

# CVIC II Controllers

V 5.1.X

Operator's manual

Model	Part number
CVIC II L2	6159326760
CVIC II L4	6159326780
CVIC II H2	6159326770
CVIC II H4	6159326790



## Original instructions.

© Copyright 2018, Ets Georges Renault 44818 St Herblain, FR

All rights reserved. Any unauthorized use or copying of the contents or part thereof is prohibited. This applies in particular to trademarks, model denominations, part numbers and drawings. Use only authorized parts. Any damage or malfunction caused by the use of unauthorised parts is not covered by Warranty or Product Liability.



## TABLE OF CONTENTS

<b>1 - SAFETY INSTRUCTIONS .....</b>	<b>5</b>	<b>6 - RESULTS .....</b>	<b>18</b>
1.1 - Statement of use .....	5	<b>7 - PROGRAMMING.....</b>	<b>19</b>
1.2 - General instructions .....	5	7.1 - CYCLES and PARAMETERS menu .....	19
<b>2 - INTRODUCTION .....</b>	<b>5</b>	7.2 - LEARNING menu .....	19
2.1 - CVIC II range.....	5	7.3 - CYCLES menu .....	20
2.2 - Controllers .....	5	7.3.1 - Introduction.....	20
2.3 - Communication .....	5	7.3.2 - Selecting the cycle .....	21
2.4 - Tools .....	5	7.3.3 - Cycle general parameters .....	21
2.5 - CVIPC 2000 .....	7	7.3.4 - Programming the phase .....	23
2.6 - CVINET WEB .....	7	7.3.5 - Programming the parameters.....	24
2.7 - PC Software evaluation version .....	7	7.4 - QUICK CYCLES menu.....	29
<b>3 - DESCRIPTION .....</b>	<b>8</b>	7.5 - SPINDLE menu .....	30
3.1 - Delivered equipment .....	8	7.6 - STATION menu .....	31
3.2 - Dimensions.....	8	7.6.1 - STATION – General parameters .....	32
3.3 - Characteristics.....	8	7.6.2 - INPUT / OUTPUT configuration .....	34
3.4 - Front panel .....	9	7.6.3 - INPUT menu.....	35
3.5 - Bottom panel .....	9	7.6.4 - OUTPUT menu.....	37
<b>4 - INITIAL START UP .....</b>	<b>10</b>	7.6.5 - REVERSE menu .....	38
4.1 - Installation .....	10	7.7 - PERIPHERALS menu .....	39
4.1.1 - STOP signal .....	10	7.7.1 - SERIAL PORT menu .....	39
4.1.2 - Switch OFF.....	10	7.7.2 - ETHERNET CONFIGURATION menu .....	39
4.1.3 - Wall mounting fixation .....	10	7.7.3 - ETHERNET SOCKET 1 menu .....	40
4.1.4 - Tool cable connection.....	11	7.7.4 - ETHERNET SOCKET 2 menu .....	40
4.1.5 - 115/230 VAC cable connection .....	11	7.7.5 - PLC menu .....	40
4.1.6 - Switch ON .....	11	7.7.6 - REPORT OUTPUT menu.....	41
4.2 - Start up.....	12	7.7.7 - BAR CODE menu.....	42
4.2.1 - How to enter or modify an alphanumeric field ..	12	7.7.8 - CVINET menu .....	42
4.2.2 - Language selection .....	12	7.7.9 - TOOLSNET menu .....	43
4.2.3 - Setting the date and time .....	13	7.8 - CONTROLLER menu.....	44
4.2.4 - Contrast adjustment .....	13	<b>8 - MAINTENANCE .....</b>	<b>45</b>
4.2.5 - Access code .....	14	8.1 - MAINTENANCE menu .....	45
4.2.6 - Activation code .....	15	8.1.1 - TEST menu .....	45
<b>5 - CONTROL SCREENS .....</b>	<b>16</b>	8.1.2 - CHANNEL TEST menu .....	46
5.1 - Standard screen .....	16	8.1.3 - COUNTERS menu .....	46
5.2 - Tightening report .....	16	8.1.4 - CALIBRATION menu.....	47
5.3 - Inputs / Outputs.....	16	8.1.5 - Options.....	47
5.4 - Barcode reading .....	16	8.1.6 - BRDx2 - controller backup .....	48
5.5 - Maintenance request.....	17	8.2 - SERVICE menu.....	48
5.6 - Controller temperature .....	17	8.3 - Maintenance operation.....	48
5.7 - Not ready.....	17	8.3.1 - Changing the memory battery .....	48
		8.3.2 - Replacing the fan .....	49
		8.3.3 - Desoutter Tool and Account Services.....	49

<b>9 - CONNECTIONS .....</b>	<b>50</b>	<b>12 - CYCLE FLOW CHART AND TIMING CHART .....</b>	<b>59</b>
9.1 - PC wiring diagram .....	50	12.1 - Cycle flow chart.....	59
9.2 - Synchronizing several CVIC controllers .....	50	12.2 - Cycle timing chart.....	59
9.2.1 - Example of connection diagram.....	50		
9.3 - Tool cables .....	51	<b>13 - TROUBLE SHOOTING HELP .....</b>	<b>60</b>
9.3.1 - EC cable.....	51	13.1 - Warning .....	60
9.3.2 - MC cable .....	51	13.2 - Report codes .....	60
9.3.3 - EC - MC extension cable.....	51	13.3 - Operating problems due to adjustment problems .....	64
		13.4 - Operating problems due to wear or breakdown.....	66
<b>10 - PRINTING FORMAT FOR TIGHTENING RESULTS.....</b>	<b>52</b>	<b>14 - GLOSSARY .....</b>	<b>68</b>
10.1 - PC2 format .....	52		
10.2 - PC3 format .....	52		
10.3 - PC4 format .....	53		
10.3.1 - Title.....	53		
10.3.2 - Result .....	53		
10.4 - PC5-A format.....	54		
10.4.1 - Report per spindle: torque rate, torque, angle.....	54		
10.4.2 - Reading results of spindle 1 (x times the number of spindles) .....	54		
10.5 - PC5-B format.....	54		
10.5.1 - Report per spindle: torque, angle, torque rate .....	54		
10.5.2 - Available parameters programmed for 1 spindle (x times the number of spindles).....	55		
10.5.3 - Results of spindle 1 (x times the number of spindles) .....	55		
<b>11 - TIGHTENING STRATEGY GUIDE.....</b>	<b>56</b>		
11.1 - Torque control.....	56		
11.2 - Torque control and angle monitoring .....	56		
11.3 - Angle control and torque monitoring.....	57		
11.4 - Prevailing torque control.....	57		
11.5 - Loosening - torque control and angle monitoring .....	58		
11.6 - Untightening - angle control and torque monitoring .....	58		

## 1 - SAFETY INSTRUCTIONS

### 1.1 - Statement of use

This product is intended to be used to drive, monitor and control the EC/ MC range tools.

No other use permitted.

For professional use only.

EMC restriction of use: for industrial use only.

### 1.2 - General instructions



To reduce risk of injury, everyone using, installing, repairing, maintaining, changing accessories on, or working near this tool must read and understand the safety instructions before performing any such task. Failure to follow all instructions listed below may result in electric shock, fire and/or serious personal injury.

General safety instructions are collected in the 6159931790 tool safety booklet and quick start user manual 6159932180.



**SAVE THESE INSTRUCTIONS CAREFULLY.**

## 2 - INTRODUCTION

### 2.1 - CVIC II range

The electric tightening system is automatically controlled by measuring the power consumption of the tool and monitoring the angle rotation.

This technology provides a complement to the range of traditional systems fitted with a torque transducer.

The electric power tool are either hand held (EC), fixed (MC, MCL) or ECPHT series.

ECPHT series are high pistol grip tools equipped of 2 mechanic speeds to provide a fast free speed and high final torque. These tools need specific ways to drive the motor and it is the reason why there are in this manual specific modes described for ECPHT tools.

### 2.2 - Controllers

CVIC II range is composed of 4 models, 2 hardware models:

- one to drive low torque tools as ECS (ending by 2)
- the other to drive the more powerful tools (ending by 4).

For each hardware model there are 2 software versions:

- L version allows only one tightening program (1 cycle).
- H version allows up to 15 tightening cycles.

The different models are:

- CVIC II L2
- CVIC II L4
- CVIC II H2
- CVIC II H4

Main differences between versions	Normal mode		ECPHT mode	
	L+	H+	L+	H+
<b>Programming modes</b>				
Quick cycle	X	X		
Learning mode	X	X		
Number of cycles	1	15	1	15
Number of phases available	15	15	15	15
<b>Phase characteristics</b>				
Search sequence	X	X		
Approach	X	X		
Run down speed	X	X	X	X
Final speed phase	X	X	X	X
Action on NOK	X	X		
Run reverse	X	X	X	X
Jump to another phase	X	X	X	X
Prevailing Torque	X	X		
Synchronisation phase	X	X		
<b>Tightening strategies</b>				
Torque	X	X	X	X
Torque with angle monitoring	X	X	X	X
Angle with torque monitoring	X	X	X	X
Number of stored results	5000 to 20000 according configuration			

### 2.3 - Communication

CVIC II controllers are equipped of the following communication facilities:

- 1 Ethernet ports for CVIPC or network communication
- 1 RS232 port to connect barcode readers or CVIPC 2000
- 8 Logical Inputs and 8 logical Outputs.
- Optional fieldbus module.

### 2.4 - Tools

The complete range of Current Control tool can work with CVIC II controllers. Every tool has a memory. When connecting the tool to a controller, the controller recognises the tool and set automatically all specific parameters.

The selection of the tool takes account of the operating conditions as stated by the user, who shall not exceed the operating limits as specified by the manufacturer at the time of the selection.

Any excessive internal temperature (over 100°C) of the tool electric motor is detected and stops the tool. It can start again only if the temperature decreases below 80°C.

Normal mode				ECPHT mode
CVIC II L2 CVIC II H2		CVIC II L4 CVIC II H4		CVIC II L4 CVIC II H4
To control tools with a very low torque		To control the other tools in the range, except for ECPHT tools		To control ECPHT tools (high Torque)
Handheld tools	Fixed tools	Handheld tools	Fixed tools	Handheld tools
ECP3L ECP5L ECP10L ECP20L ECP3LT ECP5LT ECP10LT ECP20LT ECP5  ECL1 ECL3 ECL5 ECL8 ECL11 ECLA1 ECLA3 ECLA5 ECLA8 ECLA11  ECD5 ECA15  ECS06 ECS2 ECS4 ECS7 ECS10 ECS16  ECS06 M20 ECS2 M20 ECS4 M20 ECS7 M20 ECS10 M20 ECS16 M20  ECSA2 ECSA7 ECSA10	MC35-10  ECSF06 ECSF2 ECSF4 ECSF7 ECSF10 ECSF16  ECF3L ECF5L ECF10L ECF20L	ECP20S ECP30S ECP20 ECP30 ECP40S  ECD20 ECD30 ECD50 ECD70 ECD120  ECA20 ECA30 ECA40 ECA60 ECA70 ECA90 ECA115 ECA125 ECA150 ECA200	MC35-20 MC38-10 MC38-20 MC51-10 MC51-20 MC60-10 MC60-20 MC60-30 MC80-10 MC80-20 MC80-30 MC80-40 MC106-10 MC106-20  MCL38-20 MCL51-20 MCL60-20 MCL60-30 MCL80-40  MC24-20 OF MC26-50 OF MC30-80 OF MC36-140 OF MC40-115 OF  ECF20S ECF30S	 ECPHT ECP190 ECP550 ECP950 ECP1500 ECP2100 ECP3000 ECP4000  ECP100R ECP190R ECP550R ECP950R

## 2.5 - CVIPC 2000

CVIPC 2000 is an optional PC software package.

It offers easy and user-friendly programming and real time monitoring of CVIC II controllers.

CVIPC 2000 can be installed on standard PCs running Windows 2000, XP or Vista and communicates with CVIC II controller via ethernet TCP/IP or RS232 port.

The real time monitoring functions include access to Cpk, operator monitor, etc.

## 2.6 - CVINET WEB



CVINET WEB is intended to collect & store 100% tightening data in a real-time database with advanced analytics via a web based software in service mode.

## 2.7 - PC Software evaluation version

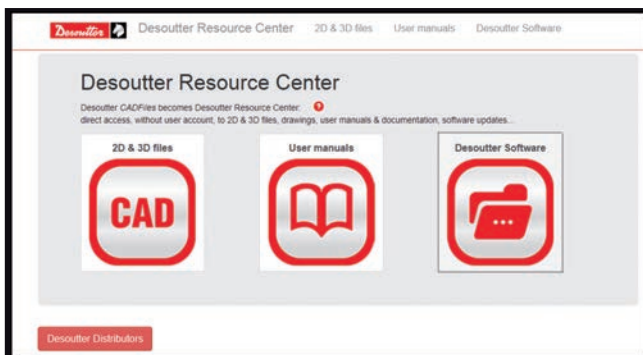

It is possible to download an evaluation version from the following web site:

<http://resource-center.desouttertools.com>

To access to last software up-date, select "Software" tab.

No password is required.

### 3 - DESCRIPTION

#### 3.1 - Delivered equipment

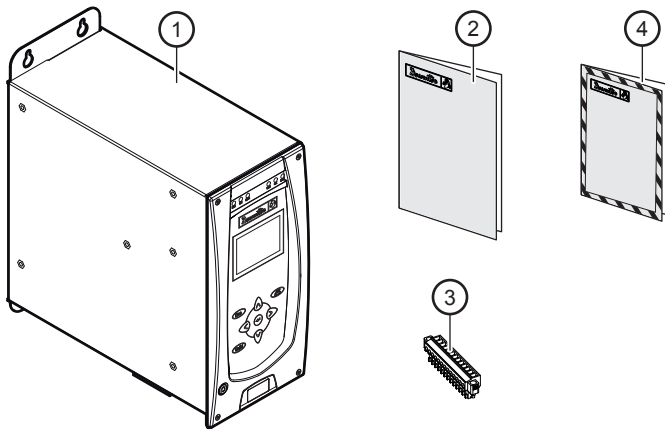

#### Legend

- 1 CVIC II box
- 2 Quick start manual
- 3 Input / Output connector with "stop" jumper
- 4 Safety manual

#### 3.2 - Dimensions

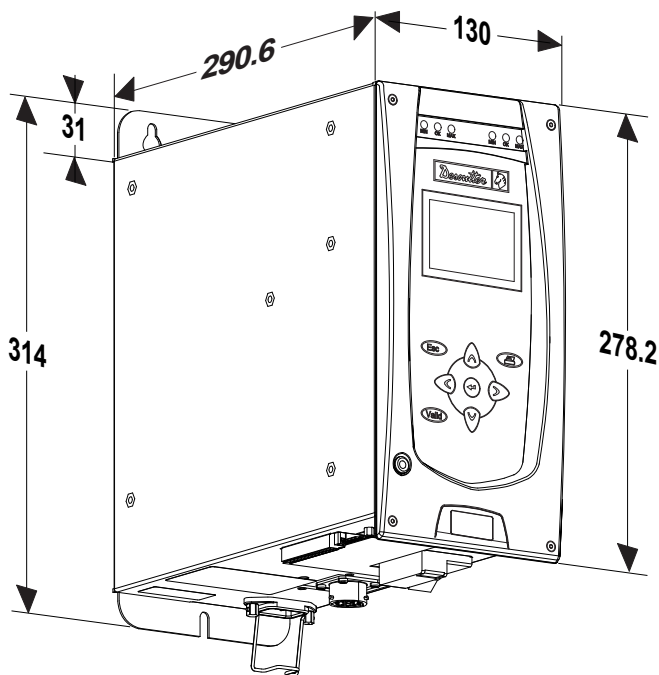

#### 3.3 - Characteristics

- Weigh: 5.9kg
- IP: 40
- Working temperature: 0 / +45°C
- Voltage:  
85 – 125VAC / 180 – 250VAC single phase, with automatic switching voltage between 110 and 230VAC.
- Frequency: 50 / 60 Hz
- Average power CVIC II 2: 0.5 kW
- Peak power CVIC II H2:
  - 1kW (tool cable 5m)
  - 1.5kW (tool cable 35m)
- Average power CVIC II H4: 0.65 kW
- Peak Power CVIC II H4:
  - 3kW (tool cable 5m)
  - 4.5kW (tool cable 35m)



## 3.4 - Front panel

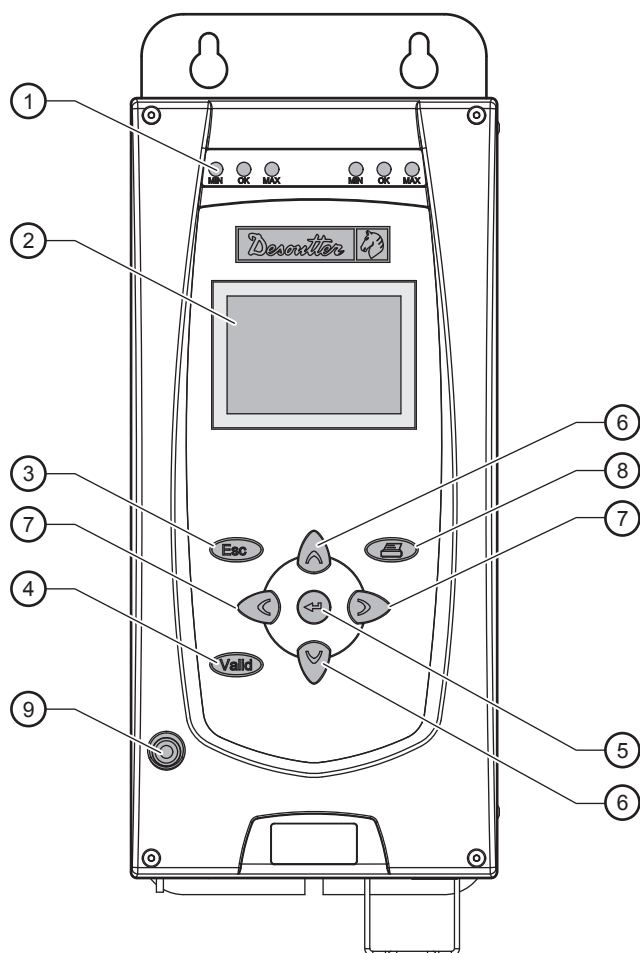

## Legend

- 1 Min, OK, Max Leds for the display of tightening report
- 2 Display
- 3 Escape key to exit a screen without change
- 4 Validate key to exit a screen and save all changes
- 5 Enter key
  - for an alphanumeric value
  - to validate a change
  - to display the next screen
- 6 Up / Down key
  - to scroll through a menu
  - to scroll through a data entry screen
  - to increment digits in digital entry mode
- 7 Left / Right key
  - to scroll through a (lozenge-tagged) list
  - to scroll through a data entry field
  - to enter an alphanumeric value
- 8 Print key
- 9 On/Off mains power indicator

## 3.5 - Bottom panel

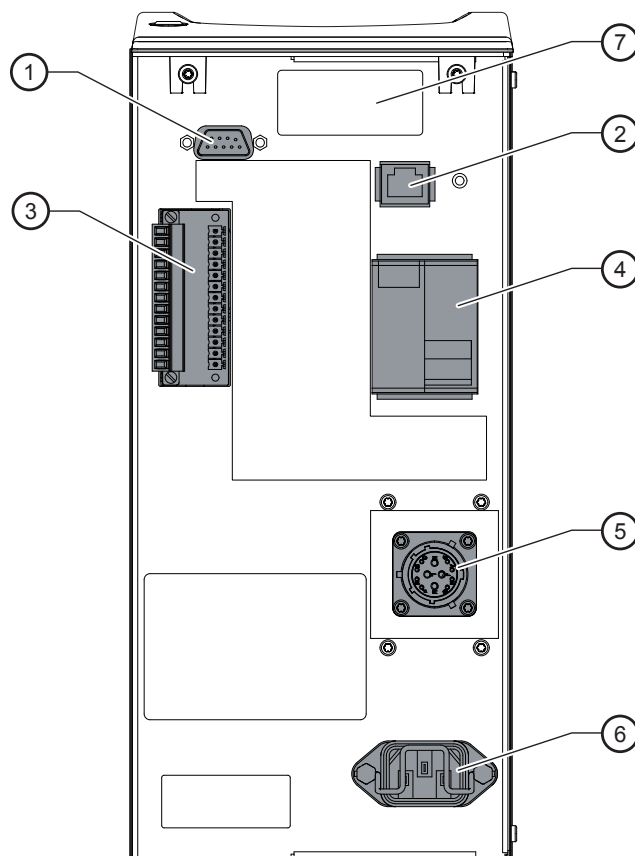

## Legend

- 1 RS232 port, SubD 9 points
  - PC cable ref.: 6159170470
  - Printer cable ref.: 6159170110
  - BRDx2 ref.: 6159363280
- 2 Ethernet port
- 3 8 inputs / 8 Outputs connector for PLC or indicator box or socket tray connection, it includes the STOP signal
- 4 ON / OFF switch, over current protection and ground fault protection
- 5 Tool connection
- 6 Mains power inlet
- 7 Field bus module (optional)

## 4 - INITIAL START UP

### 4.1.3 - Wall mounting fixation

#### 4.1 - Installation



Before switching on, make sure that the controller is installed in accordance with the installation and safety instructions mentioned in this manual, see "Safety instructions", page 5.

#### 4.1.1 - STOP signal

Check that the "STOP" signal is correctly connected to the Input connector of the controller. The STOP can be connected either to the PLC, or to a push-button close to the tightening station.

If not connected, check that the jumper is correctly positioned.

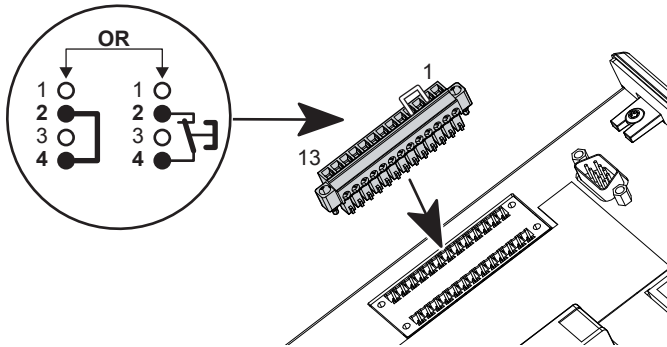

The opening of the STOP contact disables the power circuit. Note that it is recommended to wire the STOP when using handheld tools, but that it is absolutely necessary for fixed tools.

#### 4.1.2 - Switch OFF

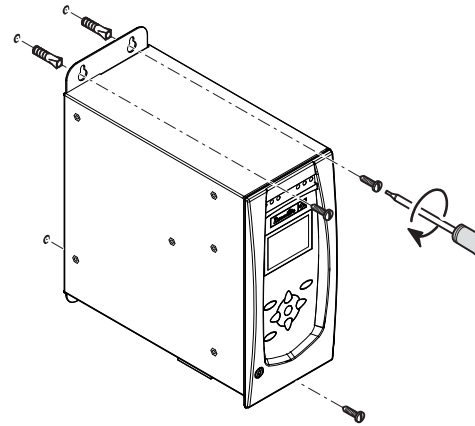
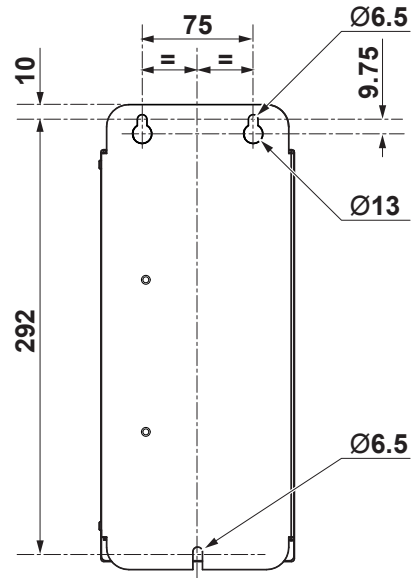
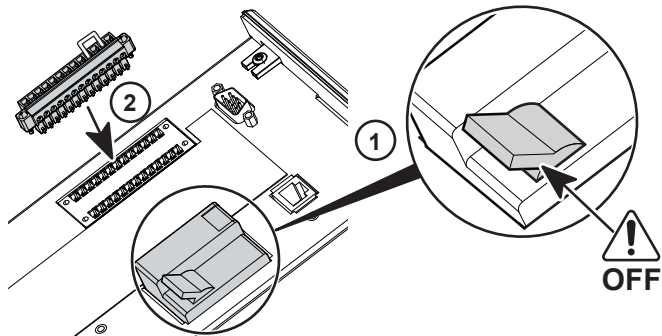

Make sure the fasteners are adapted to support and to the device.

## 4.1.4 - Tool cable connection



- Do not connect several extension cables together.
- Preferably use the longest length of extension cable and the shortest length of tool cable.
- In case of failure when implementing the extension cables, contact your local Desoutter representative for more information.

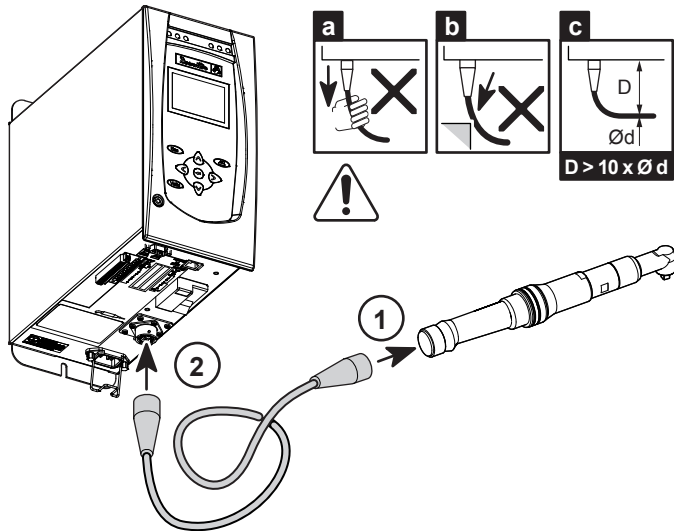

Although our cables are designed to work under drastic conditions, we recommend that you check the following points for longer service life:

- Bending radii should not be lower than 10 times the cable diameter (c).
- Friction with the outer sheath should be restricted (b).
- Any direct pull on the cable should be avoided (a).

## 4.1.5 - 115/230 VAC cable connection

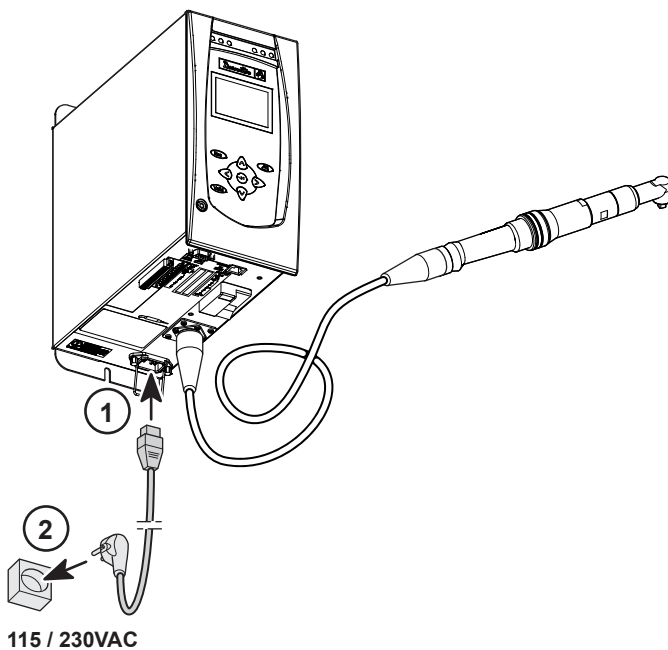

## 4.1.6 - Switch ON

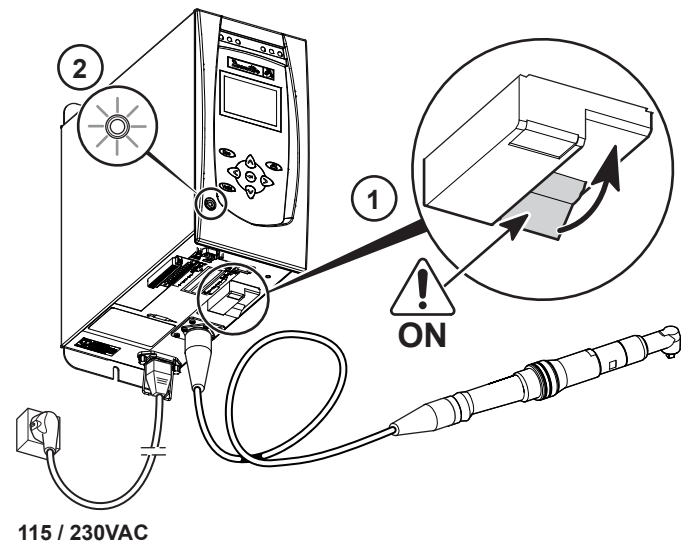

## 4.2 - Start up

When switched on, the controller automatically detects the correct operation of the tool and of the controller itself.

If everything is OK, the control screen is displayed by the CVIC.

If a problem occurs when the controller is switched on, the screen displays: NOT READY.

Press to display a second screen which provides more details about the cause of the problem.

### 4.2.1 - How to enter or modify an alphanumeric field

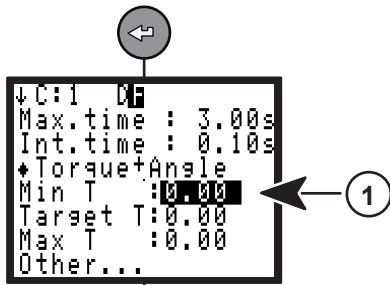

- Press to position the cursor under the different field (1).

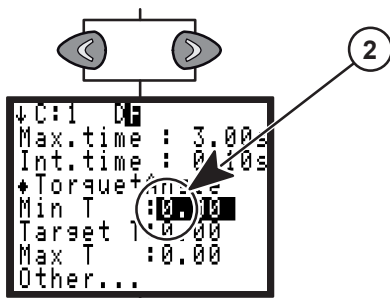

- Press or to position the cursor under the desired character (2).

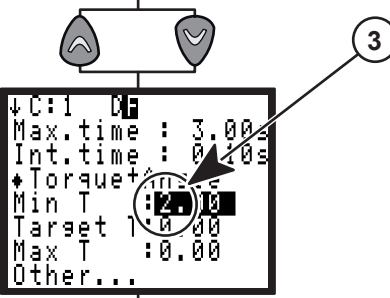

- Press or to change the field (3).
- Press or to position the cursor under the next character.
- When finished, press to validate.

### 4.2.2 - Language selection

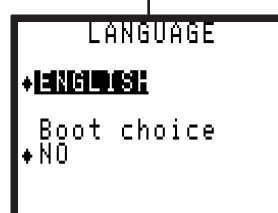
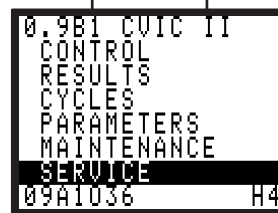
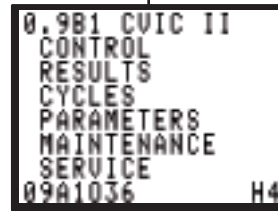
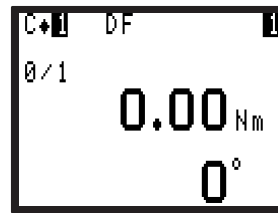

4.2.3 - Setting the date and time

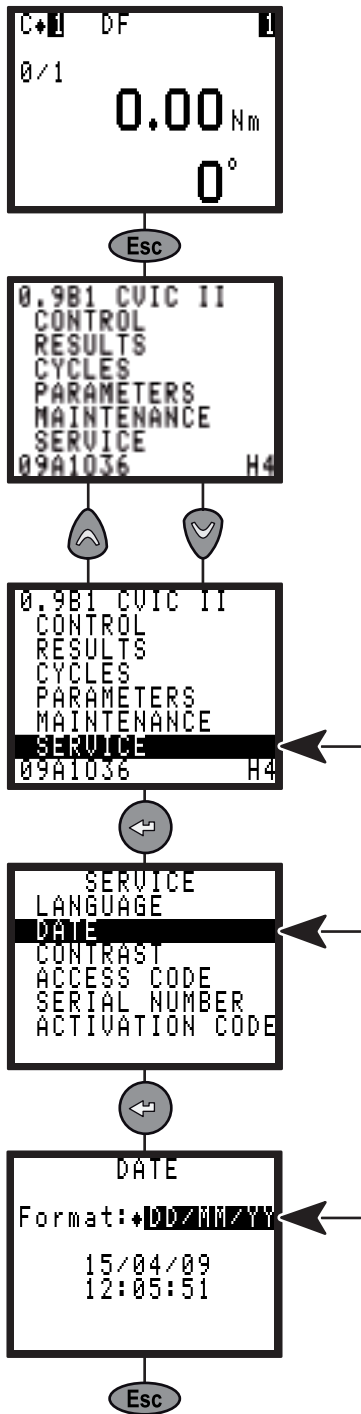

4.2.4 - Contrast adjustment

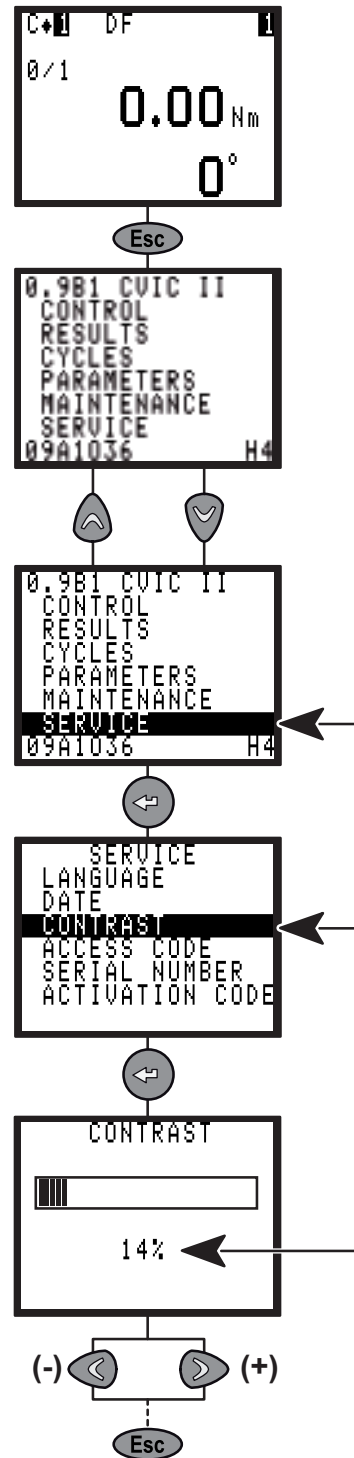

 Press  or  to adjust the contrast and validate.





### 4.2.5 - Access code

The access code is used to protect the controller against any keying error.

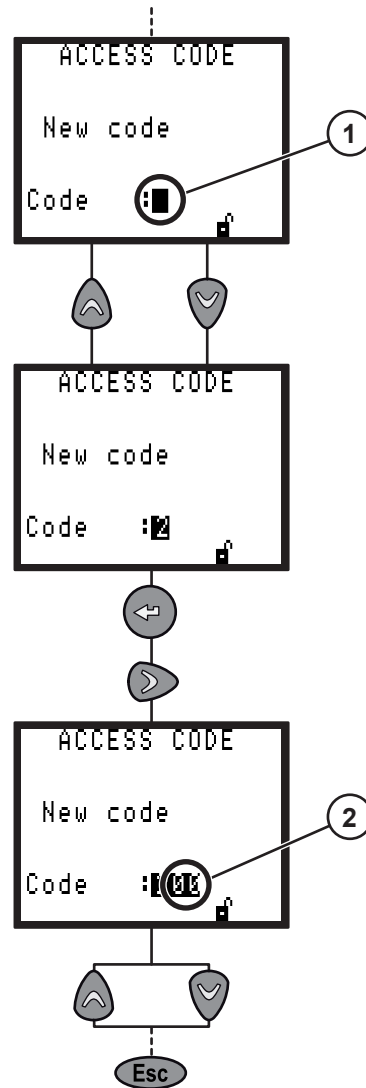
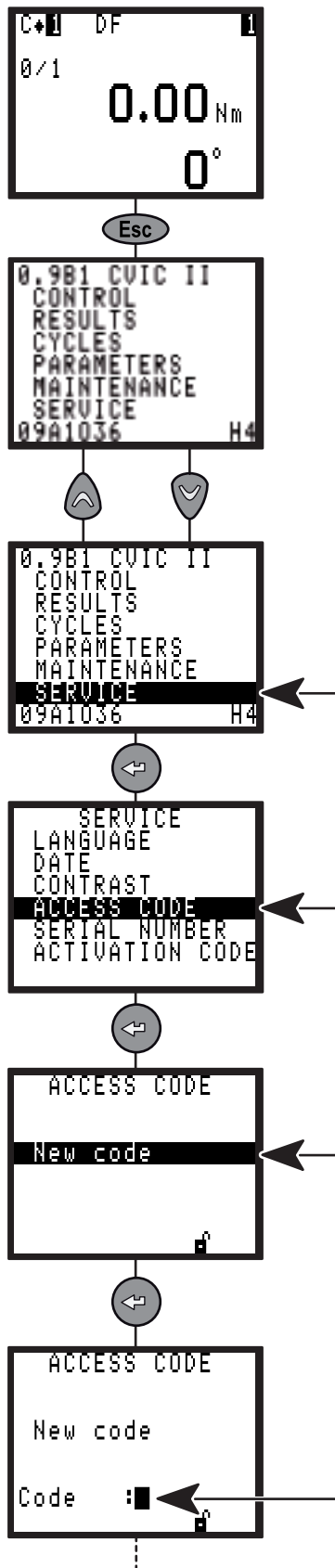
At the time of delivery, no code is programmed; the  icon is displayed on the screen.

Enter the new code.



- Press  or  to write (1).
- Press  to validate.
- Press  or  to position the cursor under the next character (2).

Lock access by entering your code again. The padlock icon will lock  meaning that writing is prohibited.



If an access code has been programmed and the operator wants to change the data stored, it is necessary to enter the code each time the controller is switched on.

 8 alphanumerical characters maximum.

## 4.2.6 - Activation code

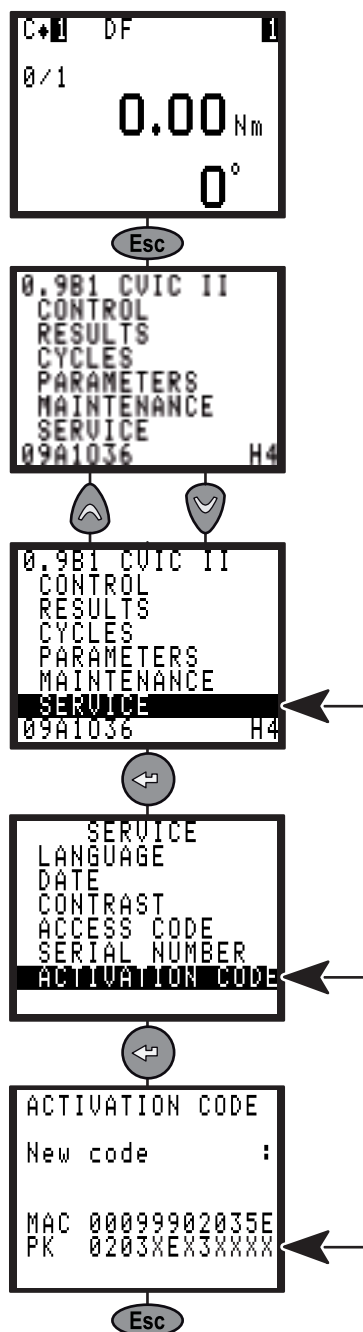

Some controller functionalities are protected by an activation code associated to a software license.

To get the activation code corresponding to a functionality (for example the communication to a ToolsNet data base), you will need the "PK" number of the controller given in the above example.

After the registration procedure you will get the activation code to be completed in this screen, activating the functionality.

## 5 - CONTROL SCREENS

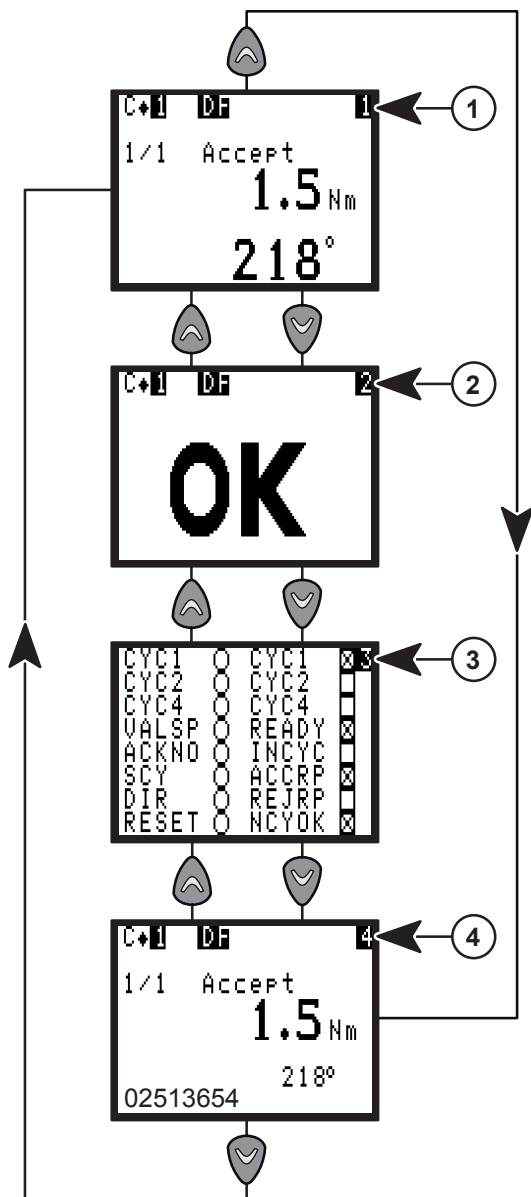

- Press to display an additional message providing information on the origin of the fault.
- Press or to move from one screen to another.



>>> When CVINET or TOOLSNET FIFO alarm threshold is reached, this symbol is blinking at the top of the Control screen.

**E09** CVINET FIFO is full.  
The cycle can not start because the Locking on when FIFO is full option is validated and there is no free memory space left in the FIFO.  
Problem with the Ethernet connection or configuration may be the cause.

**e09** CVINET FIFO is full.  
The cycle can start but there is no free memory space left in the FIFO.  
Problem with the Ethernet connection or configuration may be the cause.

### 5.1 - Standard screen

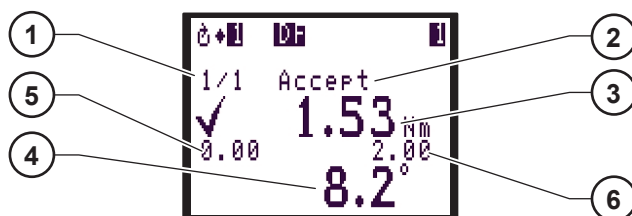

#### Legend

- 1 Counter
- 2 Status of the NcyOK counter
- 3 Tightening results
- 4 Detailed tightening report
- 5 Min. torque
- 6 Max. torque

This screen displays the tightening results of the last run cycle (3), the detailed tightening report (4) and the status of the NcyOK counter (2).

### 5.2 - Tightening report

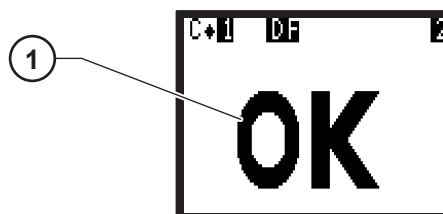

#### Legend

- 1 Tightening report

This screen displays the tightening report (1) : OK or NOK.

### 5.3 - Inputs / Outputs

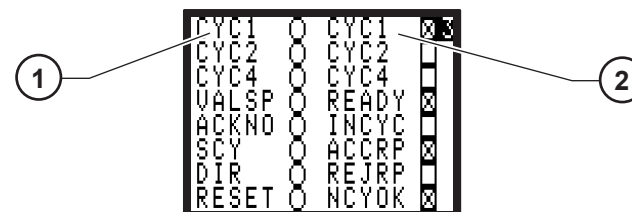

#### Legend

- 1 Status of inputs
- 2 Status of outputs

This screen provides information on the status of inputs (1) (left-hand column) and outputs (2) (right-hand column) according to tightening report.

### 5.4 - Barcode reading

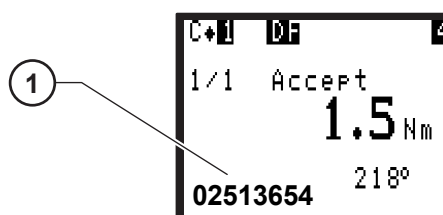

#### Legend

- 1 result of a bar code reading

This screen displays the result of a bar code reading (1).



### 5.5 - Maintenance request



This icon will blink on the Control screen when the maintenance is ON.

Refer to chapter 8.1.3.1 – Maintenance info screen.

### 5.6 - Controller temperature



This icon will blink at the bottom right of the Control screen when the controller temperature is higher than 65°C.



If the temperature reaches 70°C, the controller will stop working for safety reasons.

### 5.7 - Not ready

**NOT READY**

This icon will blink at the top of the screen when an unsupported tool is connected to the controller.



Press this icon to display the message:



## 6 - RESULTS

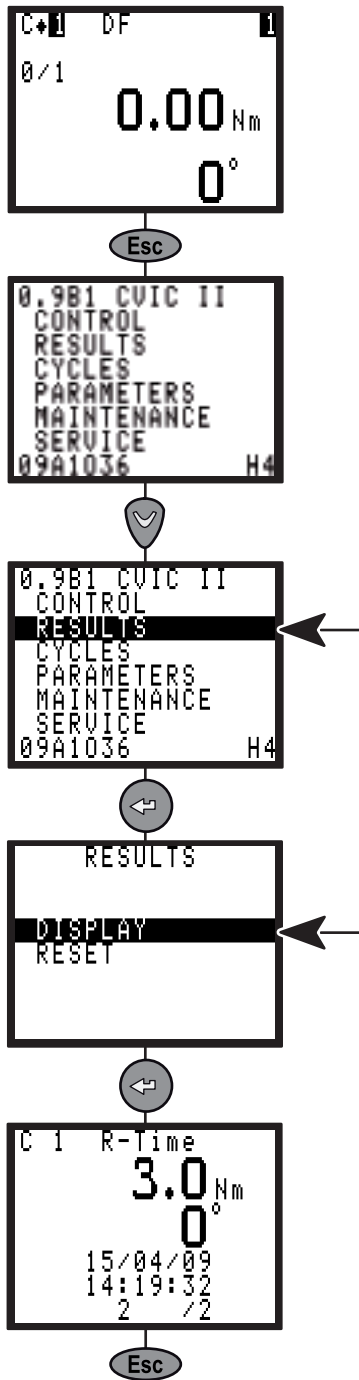

This menu allows you to display and delete the tightening results.

## 7 - PROGRAMMING

### 7.1 - CYCLES and PARAMETERS menu

The CYCLES menu allows you to:

Action	Menu
Determine the best programming	LEARNING
Change the programming of a cycle in detail	CYCLES
Quickly program a cycle	QUICK CYCLES

The PARAMETERS menu allows you to:

Action	Menu
Display the tool features	SPINDLE
Dedicate the application	STATION
Program the serial port, the report output, the bar code	PERIPHERALS
Program a comment, Bolt number	CONTROLLER

### 7.2 - LEARNING menu

This is a very simple and fast way and to program a cycle for non expert people.

The controller adapts automatically speeds and all other parameters by analysing the joint.

Nevertheless if you are not completely satisfied it is always possible to adjust any parameters using the CYCLES menu.

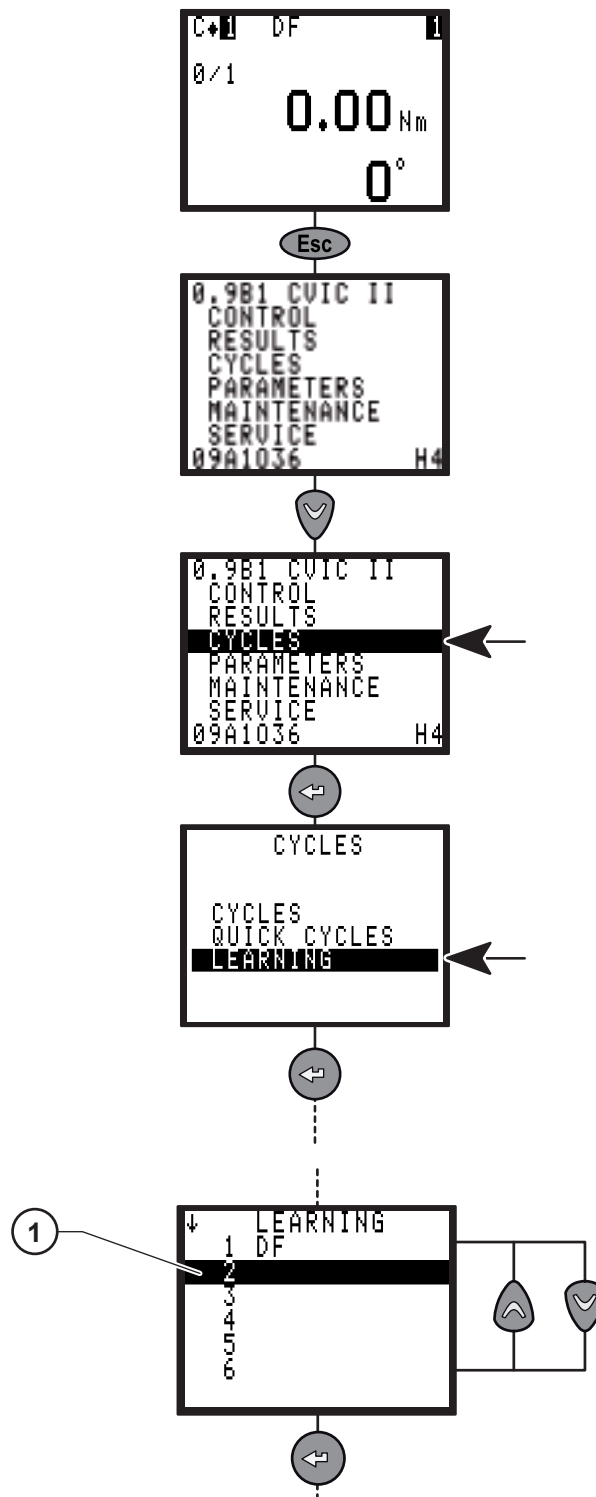

**Legend**

- 1 Cycle
- Press or to select a cycle.
- Press to validate.

## 7.3 - CYCLES menu

### 7.3.1 - Introduction

The CYCLES menu allows you to change or create the programming of the cycles.

A tightening cycle consists of a sequence of phases run consecutively.

Each phase is defined by main parameters and tightening instructions according to the selected type of tightening and motor settings.

Various phases available in a cycle	Letter	Normal mode	ECPHT mode
Search sequence	S	X	
Run down speed	D	X	X
Final speed	F	X	X
Run reverse	R	X	X
Act. on NOK	V	X	
Jump	J	X	X
Prevail. Torque	P	X	
Synchr. waiting	W	X	
Angle rundown	d	X	
Empty phase		X	X

The procedure for programming the cycle can be broken down as follows:

- Selecting the station mode: Normal / ECPHT. Refer to chapter : 7.6.1.



Change station mode WARNING,  
Cycles will be erased.  
[OK] YES

- Selecting the cycle.
- Selecting and sequencing the phases.
- Programming the parameters of each phase.
- Selecting an Action on NOK or not.
- Entering a comment.
- Programming the Number of cycles OK.

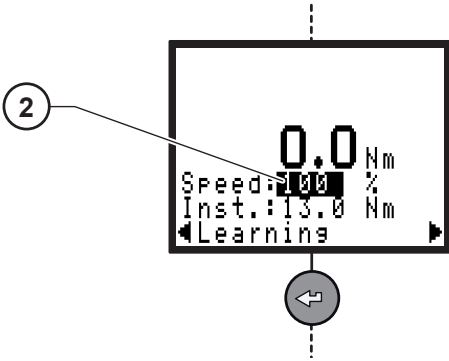

#### Legend

#### 2 Max speed limit

- Enter max speed limit (if required).
- Press to validate.

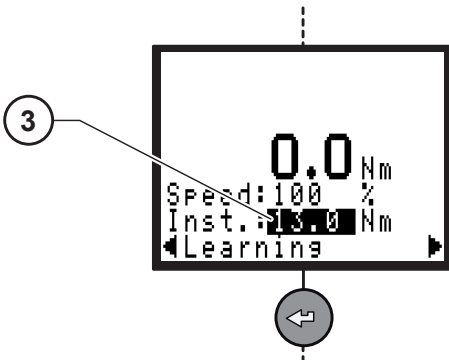

#### Legend

#### 3 Final torque

- Enter final torque.
- Press to validate.

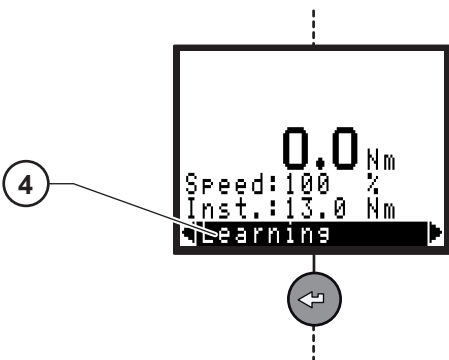

#### Legend

#### 4 Learning

- Perform 3 tightening operations.
- Press to validate.

### 7.3.2 - Selecting the cycle

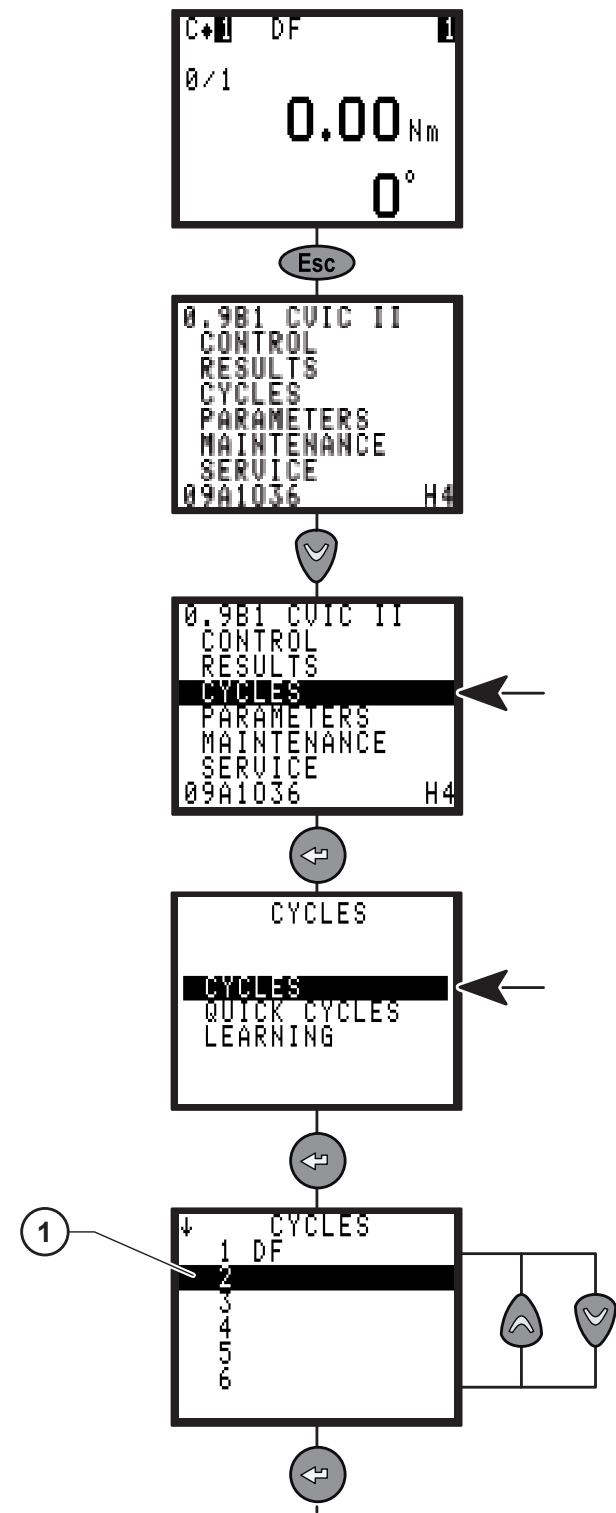

**Legend**  
1 Cycles

The list of the already programmed cycles is displayed.

- Press or to select a cycle (1).
- Press to validate.

### 7.3.3 - Cycle general parameters

#### 7.3.3.1 - Cycle general parameters (Normal mode)

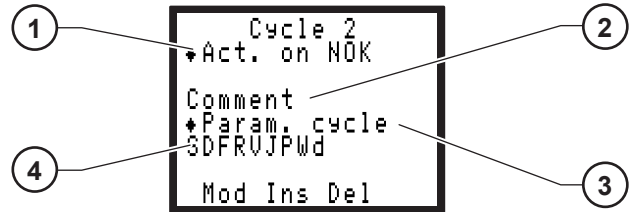

**Legend**

- 1 Action on NOK
- 2 Comment of 40 characters max.
- 3 Parameters cycle
- 4 List of the phases

#### 7.3.3.2 - Cycle general parameters (ECPHT mode)

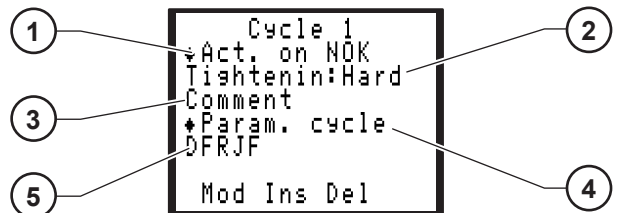

**Legend**

- 1 Action on NOK
- 2 Tightening mode: hard /normal
- 3 Comment of 40 characters max.
- 4 Parameters cycle
- 5 List of the phases

#### 7.3.3.3 - Programming the action on NOK for each cycle

Associated with the cycle, this menu allows you to detect anomalies at various stages of the tightening cycle. As soon as a reject report is emitted by a phase (Approach, Final speed phase, Run Reverse, Prevailing torque) one of the 3 following actions can be performed.

- Stop the cycle at this phase.
- Stop the cycle then run reverse a given number of rotations.
- Stop the cycle then run reverse the number of rotations already performed during the approach phase (if any).

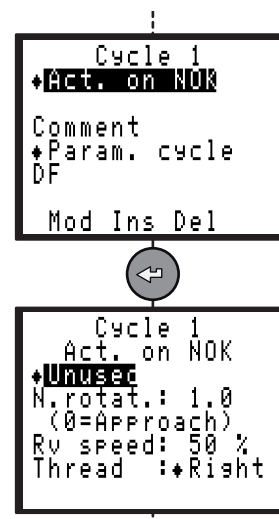

This menu is used as an alternative to the insertion of an Action on NOK Phase, with the following advantages:

- Sequencing of a cycle (Approach, Run Down Speed, Final Speed) without inter-phase stop.
- No additional phase.
- A single programming to monitor all the stages of the tightening cycle.

Except for the approach phase, this action on NOK is performed only if an inter-phase time is programmed.



**Warning: when used with hand held tools, programming an action on NOK with run reverse may be dangerous for the operator.**

Select the relevant action:

Parameter	Comment
Unused	The option is disabled.
Stop cycle	As soon as one of the torque or angle parameters is out of tolerances at the end of one of the phases, the cycle stops at the end of this phase.
Run reverse	The cycle stops under the same circumstances as in the Stop Cycle option, then the tool un-tightens with the programmed number of rotations.
N.rotat	Number of run reverse rotations performed by the tool in case of fault (0-100). The value 0 causes a run reverse action which is equal to the number of rotations performed in the approach phase if this phase has been programmed. Otherwise, the number of rotations is equal to 0.
Rv speed	Run reverse speed associated with an action on NOK per cycle or per phase.
Thread	Right / Left.



When an action on NOK phase has been programmed, it will be processed as a priority with respect to the action on NOK of the cycle.

### 7.3.3.4 - Parameters cycle (Normal mode)

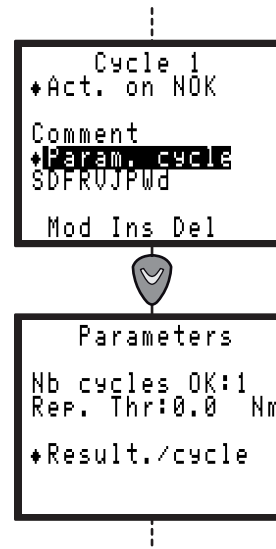

Parameter	Comment	
Nb cycles OK	Number of correct cycles to activate the NCYOK output.	
Rep. Thr	Torque threshold value to allow to send a cycle report.	
Result./cycle or phase	Cycle	The report is generated when the cycle is completed.
	Phase	The report is generated any time a phase is completed.

7.3.3.5 - Parameters cycle (ECPHT mode)

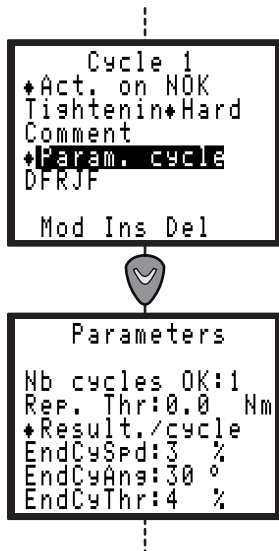

Parameter	Comment	
Nb cycles OK	Number of correct cycles to activate the NCYOK output.	
Rep. Thr	Torque threshold value to allow to send a cycle report.	
Result./cycle or phase	Cycle	The report is generated when the cycle is completed.
	Phase	The report is generated any time a phase is completed.

Parameter	Comment			
EndCySpd EndCyAng	To adjust the tool output speed and angle at the end of the cycle			
		Min. value	Default value	Max. value
	End cycle speed	0%	3%	100%
	Of the tool rotational max. speed			
End cycle angle	0°	30°	255°	
EndCyThr	Torque threshold value to activate the "end cycle speed" and the «end cycle angle» parameters.			
		Min. value	Default value	Max. value
	End cycle threshold	0%	4%	100%
	Of the tool max. torque			

7.3.4 - Programming the phase

After selecting a cycle, the cursor will move to the line where the various phases of the selected cycle are shown. You will be allowed to modify, insert or delete a phase.

7.3.4.1 - Creating (or changing) a phase

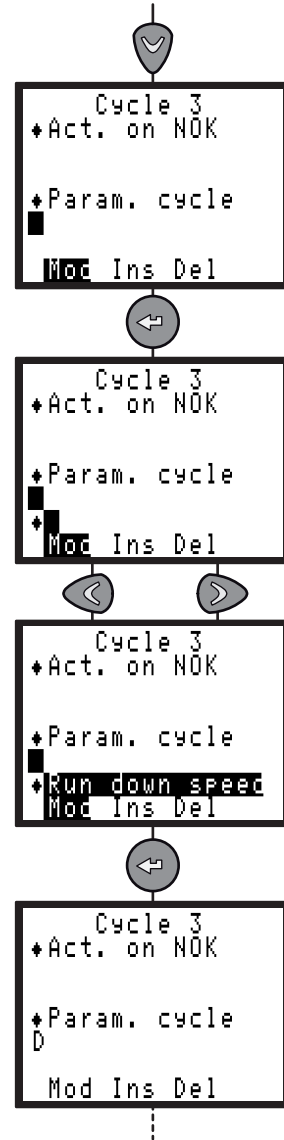

**7.3.4.2 - Inserting a phase**

- Create a blank before the phase before which you want to insert a new phase:



- Proceed as before to create a phase.

**7.3.4.3 - Deleting a phase**

- Position the cursor on the phase that you want to delete.

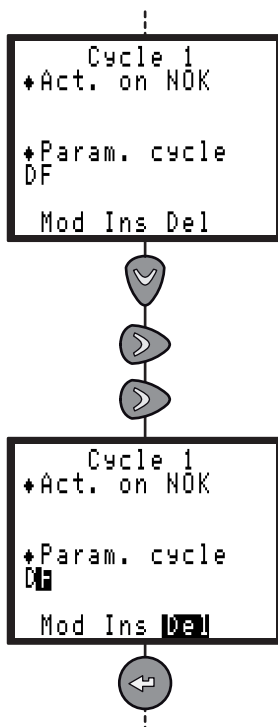

**7.3.5 - Programming the parameters**

- Using and , position the cursor on the phase whose parameters you want to program.
- Press to validate.

**7.3.5.1 - Search sequence phase**

This phase may be useful to insert the bolt head in the socket.

It allows rotating slowly the socket in one direction or the other or alternatively to a predefined angle or time.



The maximum time is simply displayed for the search sequence phase as it implicitly equals the number of rotations multiplied by the rotation time + stop time.

Parameter	Comment
Int.time	Time programmed between this phase and the next one: 0 - 20 s.
Nb rotat.	Number of rotations: 1 - 9.
Stop time	Stop time: 0 - 20 s.
Rotat.Typ	Rotation type: Time / Angle.
Rot.time or Rot.anl.	Rotation time: 0 - 50 s / rotation angle: 0 - 9,999°.
Direction	Right / Left / Alter. If the direction is alternate, half the rotations are clockwise and the other half are in the opposite direction.
Speed	Rotational speed: 0 - 100%.
Accelerat	0 - 20 s. Acceleration or deceleration time to switch from one speed to another, this parameter is enabled for the first phase and when the inter-phase time is not equal to zero. When the inter-phase time is equal to zero, acceleration is automatically optimized.

No result for this phase.



**7.3.5.2 - Approach**

It allows you to quickly approach the fastener without reaching the joint.

It is particularly recommended in the case of hard joints for which the approach speed should be restricted in order to control the final torque.

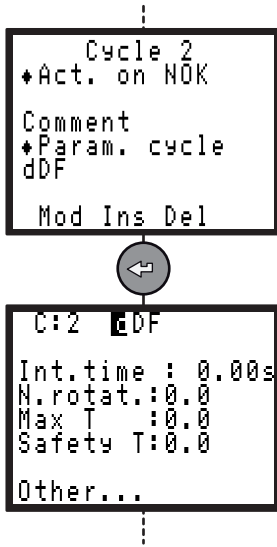

Parameter	Comment
<b>Int.time</b>	Time programmed between this phase and the next one: 0 - 20 s.
<b>Nb rotat.</b>	Number of rotations performed by the tool during this phase: 0 - 100.
<b>Max T</b>	Maximum torque that should not be reached at the end of the phase: 0 Nm to max. value of the spindle.
<b>Safety T</b>	Safety torque, stops the spindle if reached during the phase.
<b>Other...</b>	See Motor parameters.

The phase result is OK if:

- The torque is lower than the programmed maximum torque.  
AND
- If the programmed number of rotations has been reached.

**7.3.5.3 - Run Down Speed Phase (Normal mode)**

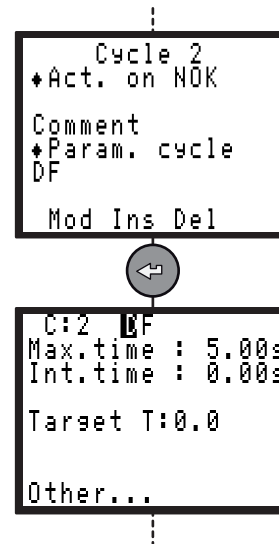

Parameter	Comment
<b>Max.time</b>	Maximum phase running time: 0.01 - 99 s.
<b>Int.time</b>	Time programmed between this phase and the next one: 0 - 20 s.
<b>Target T</b>	Target torque: 0 Nm to maximum value of the spindle (screw approach torque).
<b>Other...</b>	see Motor parameters.



No result for this phase.

**7.3.5.4 - Run Down Speed Phase in ECPHT mode**

Same parameters as for the normal Run Down Phase except Target torque which is cancelled.

There is no need to program a target torque for this tool, values are automatic.

New parameter:

Parameter	Comment
<b>Max.time</b>	Maximum phase running time: 0.01 - 99 s.
<b>Int.time</b>	Time programmed between this phase and the next one: 0.10 s minimum.
<b>Prevailing</b>	Yes / No - An offset will be added to the target torque during this phase in case of prevailing torque during this phase.

**7.3.5.5 - Final Speed Phase**  
(normal mode and ECPHT mode)

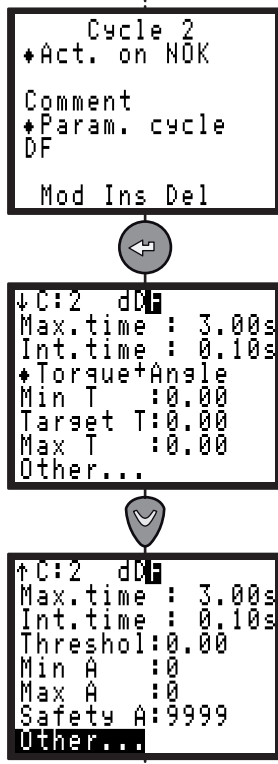

Parameter	Comment
<b>Max.time</b>	Maximum phase running time: 0.01 - 99 s.
<b>Int.time</b>	Time programmed between this phase and the next one: 0 - 20 s.
<b>Tightening strategy</b>	Torque / Torque + Angle.
<b>Additional strategy for H version</b>	Angle + Torque.
<b>Min T</b>	Minimum torque: 0 Nm to maximum value of the spindle.
<b>Target T</b>	Target torque: 0 Nm to maximum value of the spindle.
<b>Max T</b>	Maximum torque: 0 Nm to maximum value of the spindle.
<b>Threshold</b>	Angle threshold: 0 Nm to maximum value of the spindle.
<b>Latch angle</b>	The angle reading can be stopped in each individual phase in a cycle. There are 3 different settings: <ul style="list-style-type: none"> <li>• Threshold (by default): the controller starts measuring the angle when the torque is above the torque threshold, even after the motor stop.</li> <li>• Motor stop: the angle is not read anymore after the motor stop.</li> <li>• None: no latch angle.</li> </ul>
<b>Min A</b>	Minimum angle: 0 - 9,999°.
<b>Max A</b>	Maximum angle: 0 - 9,999°.
<b>Safety A</b>	Safety angle: 0 - 9,999°.

Parameter	Comment
<b>Other...</b>	See motor parameters

**i** Detailed RP: See "Tightening strategy guide", page 56" (torque, torque + angle, angle + torque and prevailing torque).

**7.3.5.6 - Action on NOK Phase (only in normal mode)**

When a report is rejected (max. torque or angle reached, etc.), it is possible to apply a specific corrective action to the cycle, either by stopping the cycle or by programming a corrective phase.

For example: untighten the screw, repeat tightening, etc.

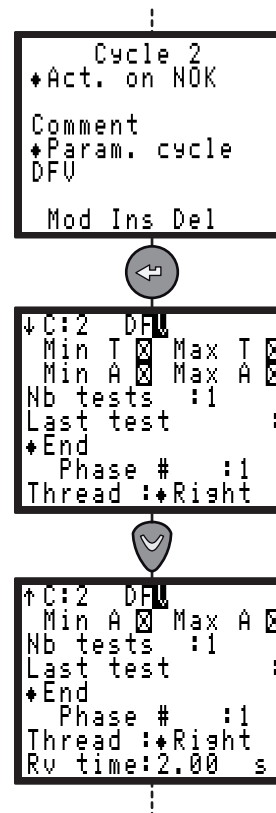

You must first choose:

- The fault(s) to which you want to apply a corrective action.
- The number of tests (from 1 to 99).

Various actions on NOK are available:

Parameter	Comment
<b>End</b>	To stop the tightening cycle.
<b>Rrv.+End</b>	A Run Reverse phase is run according to the programmed time then the cycle is stopped.
<b>Jump</b>	The cycle proceeds to the indicated phase.
<b>Rrv.+Jump</b>	A run reverse phase is run according to the programmed time, then the cycle proceeds to the indicated phase.
<b>Thread</b>	Right / Left.
<b>Rv time</b>	Run reverse time: 0 - 99 s

**i** No phase RP.

7.3.5.7 - Run reverse phase  
(normal mode and ECPHT mode)

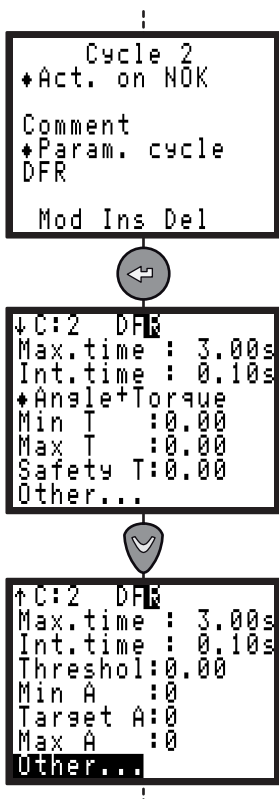

Parameter	Comment
<b>Max.time</b>	Phase running time out: 0.01 - 99 s.
<b>Int.time</b>	Time programmed between this phase and the next one: 0 - 20 s.
<b>Strategy</b>	Torque/Torque+Angle/Angle+Torque.
<b>Min T</b>	Minimum torque: 0 Nm to maximum value of the spindle.
<b>Target T</b>	Target torque: 0 Nm to maximum value of the spindle (torque or torque + angle strategy).
<b>Max T</b>	Maximum torque: 0 Nm to maximum value of the spindle.
<b>Safety T</b>	Safety torque: 0 Nm to maximum value of the spindle.
<b>B-away T</b>	Breakaway torque: starts the torque control (strategies: torque or torque + angle), must be higher than final torque.
<b>Threshold</b>	Angle threshold: 0 Nm to maximum value of the spindle.
<b>Min A</b>	Minimum angle: 0 - 9,999°.
<b>Target A</b>	Target angle: 0 - 9,999° (angle + torque strategy).
<b>Max A</b>	Maximum angle: 0 - 9,999°.
<b>Other...</b>	See motor parameters.

7.3.5.8 - Motor parameters



Parameter	Comment
<b>Fc(Hz)</b>	Bandwidth adjustment from 4 to 128Hz. Reducing this value allows you to filter the defects in the Torque signal and improve the dispersion of the torque installed (Cp or Cam), which may be useful in particular when using a Crowfoot head. Warning: as a result, the adjustment of the torque (Cpk) may be modified. It can be adjusted by calibrating the tool on the assembly ("CALIBRATION menu", page 47).  The cut-off frequency value entered will have no effect on ECPHT tools.
<b>Thread</b>	Right / Left.
<b>Speed</b>	Rotational speed: 0 - 100%.
<b>Acceler</b>	0 - 20 s. Acceleration or deceleration time to switch from one speed to another, this parameter is enabled for the first phase and when the inter-phase time is not equal to zero. When the inter-phase time is equal to zero, acceleration is optimized automatically.
<b>Reset</b>	The Reset function allows you to reset the torque and/or angle values at the beginning of the current phase.
<b>External stop</b>	Yes/No. The following conditions must be met for the system to stop the current phase and shift to the next one: <ul style="list-style-type: none"> <li>• The External Stop parameter must be on Yes in this screen.</li> <li>• The signal at the External Stop input of the Input/Output connector must shift to 1.</li> </ul>

 Detailed RP: See "Tightening strategy guide", page 56" (torque, torque + angle, angle + torque and prevailing torque).

### 7.3.5.9 - Jump to another phase (normal mode and ECPHT mode)

This phase allows you to design more sophisticated cycles. For example: D F1 V1 F2 — F3 J1

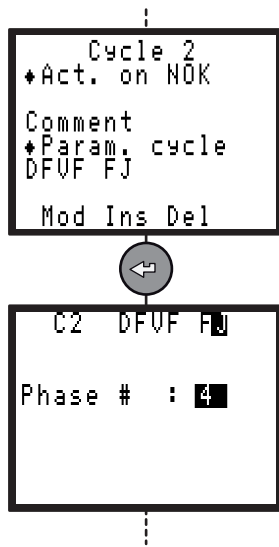

D	Phase 1	Run down speed
F1	Phase 2	Final speed
V1	Phase 3	Action on NOK: IF NOK, jump to phase 6 (F3) ELSE run phase 4 (F2), then stop the cycle
F2 P	Phase 4	Final speed
—	Phase 5	Empty phase: the cycle is stopped
F3	Phase 6	SCY phase in case of NOK on phase 2 (V1)
J1	Phase 7	Jump to phase 4 (F2) to finish

No phase RP.

### 7.3.5.10 - Prevailing Torque Phase (only in normal mode)

This phase allows you to monitor the load moment (prevailing torque) of a screw or nut.

The initial time out (expressed in time or angle) allows you to eliminate the shock pulse when starting the motor and the mechanism.



Parameter	Comment
Max.time	Phase running time out: 0.01 - 99 s.
Int.time	Time programmed between this phase and the next one: 0 - 20 s.
Target A	Target angle: 0 - 9,999°.
Min T	Minimum torque: 0 Nm to max. value of the spindle.
Max T	Maximum torque: 0 Nm to max. value of the spindle.
Safety T	Safety torque: 0 Nm to max. value of the spindle.
Start typ	Type of start: Time / Angle.
Rot.angl. or Rot.time	Rotation Angle or Time: 0-9,999° or 0 - 20 s.
Direction	Direction: Right/Left.
Speed	Rotational speed: 0 - 100%.
Accelerat	0 - 20 s.
Reset: Angle	Yes / No
Reset: Torque	Yes / No

Parameter	Comment
<b>External stop</b>	Yes / No - The following conditions must be met for the system to stop the current phase and shift to the next one: <ul style="list-style-type: none"> <li>the External Stop parameter must be on Yes in this screen.</li> <li>the signal at the External Stop input of the Input/Output connector must shift to 1.</li> </ul>

**i** Detailed RP: See "Tightening strategy guide", page 56 (torque, torque + angle, angle + torque and prevailing torque).

**7.3.5.11 - Synchro Waiting Phase (only in normal mode)**

This phase allows you to synchronize the phases of several controllers. To synchronize several controllers, you must program a waiting phase for each controller and use the Synchro signals (see "INPUT / OUTPUT configuration", page 34).

Principle:

Each controller reports to the others that it has reached its waiting phase by resetting to 0 the Synchro signal. Then it waits until the other controllers reach their own waiting phase by scanning the Synchro input.

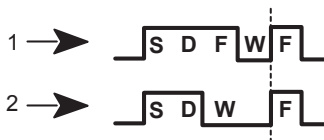

**Legend**

- 1 Controller n° 1
- 2 Controller n° 2

In the example, the controller no. 2 runs the beginning of the cycle (Search Sequence, Run Down Speed), then waits until the controller no.1 has completed its phases (Search Sequence, Run Down Speed, Final Speed) to run together the end of the cycle.

After a 10 s delay (max. time programmed by default), the controller continues or stops the cycle.

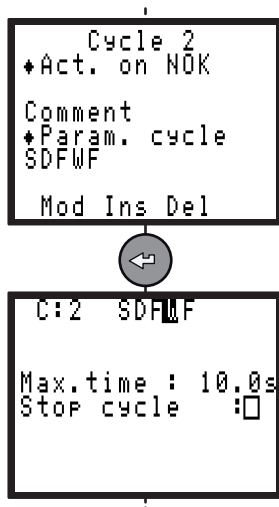

**i** No phase RP.

**7.4 - QUICK CYCLES menu**

This menu allows you to quickly program the cycles. By default, the quick cycles consist of a run down speed and final speed phase.

The operator only programs the target torque and the maximum angle on the screen.

It is the controller itself which calculates the speeds and all of the other default parameters.

Nevertheless if you are not completely satisfied it is possible to adjust any parameters using the CYCLES menu.

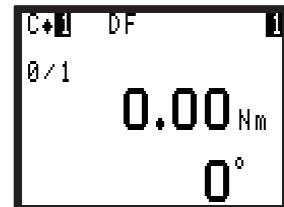

Esc

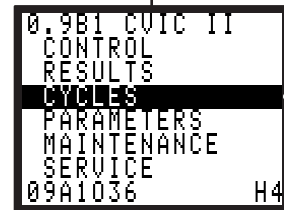

←

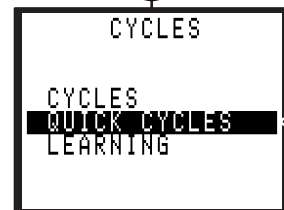

←

### 7.5 - SPINDLE menu

This menu displays controller and tool identification and characteristics.

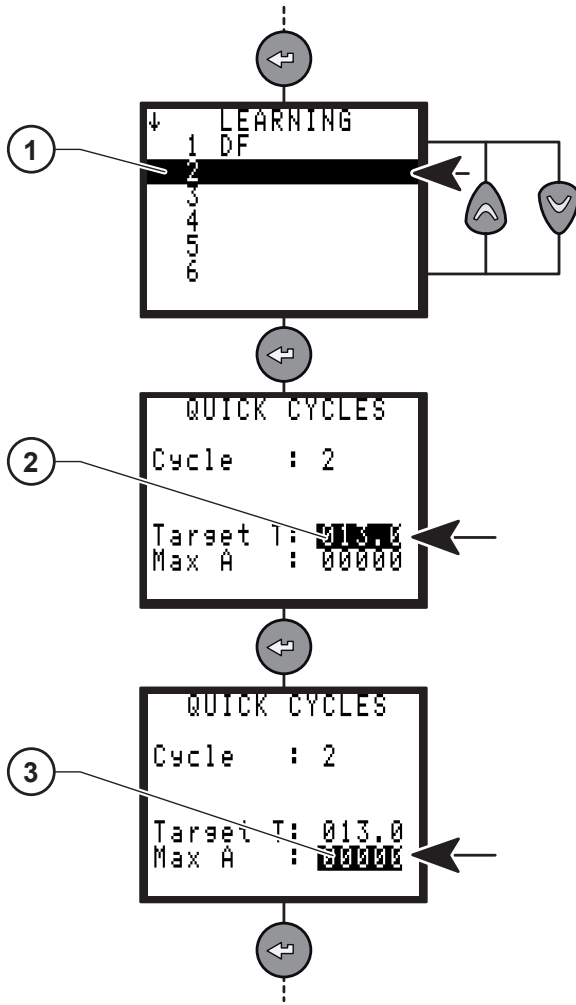

**Legend**

- 1 Cycle
- 2 Final torque
- 3 Max angle

- Press or to select a cycle (1).
- Press to validate.
- Enter final torque (2).
- Press to validate.
- Enter max Angle (3).
- Press to validate.

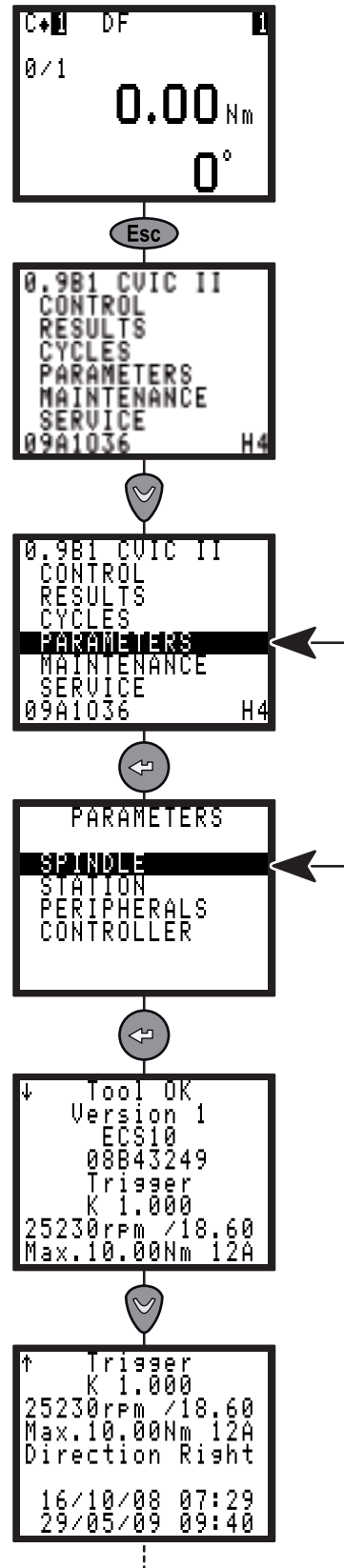

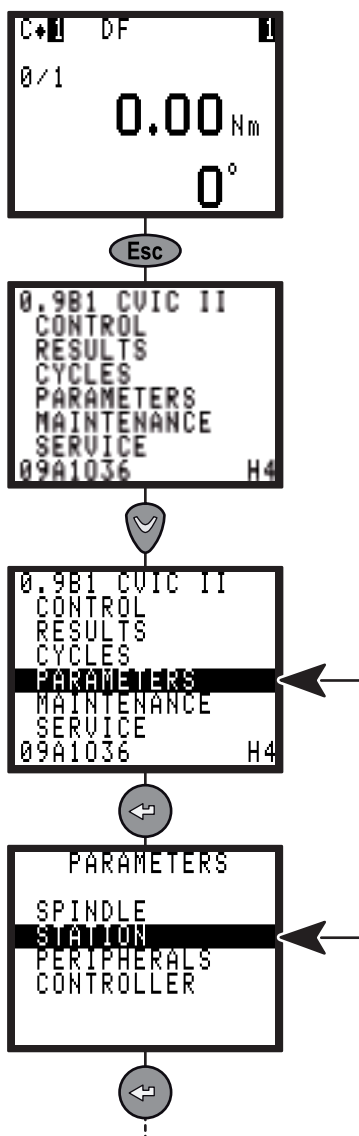

7.6 - STATION menu

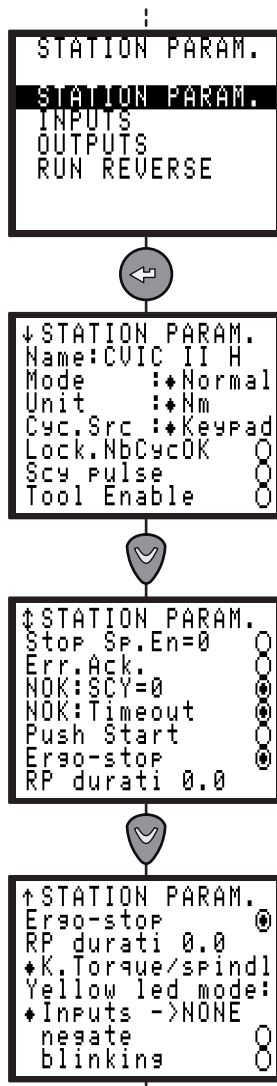

7.6.1 - STATION – General parameters



Screen name	By default	Comment
Name	-	Possibility to associate a name to the station.
Mode	Normal / ECPHT	<p>Enter ECPHT mode for ECPHT tools - and Normal mode for all other tools. When programming a cycle, the machine mode is written into the cycle. ECPHT tools cannot be used in normal mode and normal tools cannot be used in ECPHT mode: the cycle would simply not start.</p> <p> The controller must be configured in ECPHT mode for ECPHT tools to get the correct functionalities.</p>
Unit	Nm	Nm / Ft Lb / In Lb / kg m / kg cm / Ncm / InOzf / gf cm.
Cyc.Src	Keypa	Keypa / PC / Bar c / I/O - Source of the cycle number: peripheral used to program the current cycle: keyboard, PC, Bar code, Inputs/Outputs (binary programming).
Lock.NbCyOK	No	Lock N cycles OK: when this function is enabled, the system locks the start cycle as soon as the number of cycles run with an accept report has reached the programmed number of cycles. A reset command must be sent to unlock the cycle start.
Scy pulse	No	<p>Start cycle by pulses: the Start Cycle signal can be activated with a pulse. For safety purposes, this parameter is only available on fixed spindles.</p> <p> <b>Warning: It is strongly advised against programming the SCY pulse option if handheld tools are used. As the tool only stops at the end of the tightening cycle, this may result in a risk of injury for the operator.</b></p>
Tool Enable	No	Spindle validation: the spindle operation is validated or not by the PLC.



Screen name	By default	Comment
Stop sp En=0	No	Stop the tool when tool enable signal disappears. Requires Tool Enable to Yes.
Err.Ack.	No	Yes / No (to validate start cycle after a reject report).
NOK :SCY=0	Yes	Report NOK when start cycle is released. <ul style="list-style-type: none"> <li>When this function is enabled (Yes), the report is NOK and the "Scy" message is displayed when the start cycle is released.</li> <li>When the function is disabled (No), the report is OK and the "Scy" message is displayed when the start cycle is released.</li> </ul>
NOK time out	Yes	Report NOK when time out occurs. <ul style="list-style-type: none"> <li>When this function is enabled (Yes), the report is NOK and the "Time-Time" message is displayed when the time-out occurs.</li> <li>When the function is disabled (No), the report is OK and the "Time" message is displayed when the time-out occurs.</li> </ul>
Push Start	No	When the function is disabled (No), the tool Push Start is inhibited. The tool can be started either by pressing the lever or by enabling the external start input. When the function is enabled (Yes), the tool can only be started by Push Start.
Ergo-stop	Yes	When the function is enabled, the operator will experience less of a jerk at the end of the tightening operation. <div style="display: flex; align-items: center;">  <div style="margin-left: 10px;">Better inactivate Ergo-stop for ECPHT tools.</div> </div>
RP durat	0.0	A value which is different from 0 allows you to program the pulse (0.1 to 4.0 s) reports (accept, reject, NCYOK) at end of cycle. With a value equal to 0, you can program a continuous status of the reports at end of cycle.
K torque/spindle or K torque/cycle		This option allows you to define: <ul style="list-style-type: none"> <li>Either one correction coefficient per spindle, stored in the tool memory. It is set to 1 by default and can be changed using the manual calibration procedure, starting from the maintenance menu. This coefficient is used to calculate the torque, independently of the cycle run.</li> <li>Or one correction coefficient per cycle, stored in the controller memory. It is set to 1 by default and can be changed using the manual calibration procedure for each programmed cycle. The coefficient used to calculate the torque is that associated with the current cycle.</li> </ul>
Yellow LED (specific to ECS)		The yellow LED on the tool can be used to give the operator specific information. One of the following functions can be connected to the yellow LED: <ul style="list-style-type: none"> <li>Output: Free / Ready / IN CYC / Bad report / Good report / NCY OK / CYC 1 / CYC 2 / CYC 4/ SYNC / CYC 8 / CYC 16 / Torque OK / Torque NOK / Angle OK / Angle NOK.</li> <li>Negate: If ticked, the meaning of the output signal is inverted to the usual meaning.</li> <li>Blink: If ticked, the output signal blinks when activated.</li> </ul>

### 7.6.2 - INPUT / OUTPUT configuration

The STATION menu also allows you to reconfigure the addresses of the input and output functions on the I/O connector.

According to the desired operation, you can use either the default configuration, or the dedicated configuration with functions not defined in the default configuration.

All functions can be configured on any input or output available.

You can configure the same output function on several outputs of the I/O connector.

Note that there are 2 separate common circuits on OUTPUT:

- COM1 common for output 1 to 4.
- COM2 common for output 5 to 8.
- It is possible to connect COM1 and COM2 together to get a unique common circuit for all outputs.

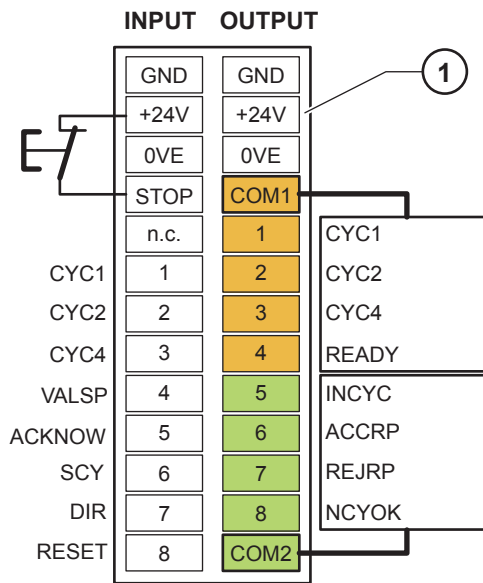

**Legend**

1 Manufacturing configuration

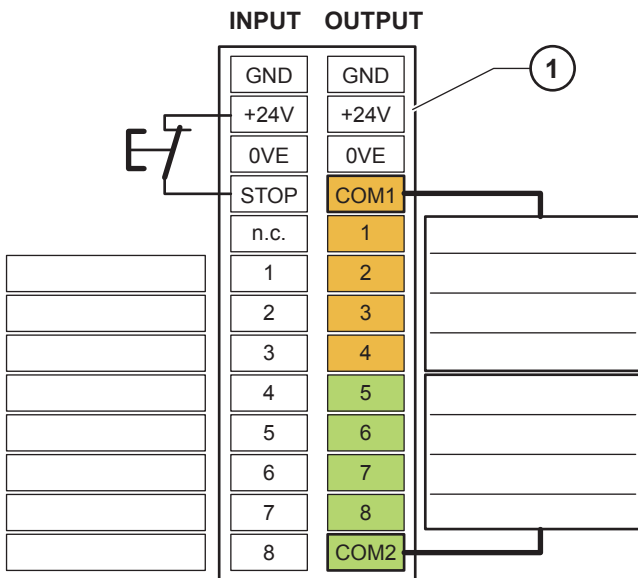

**Legend**

1 Note your customized configuration

## 7.6.3 - INPUT menu

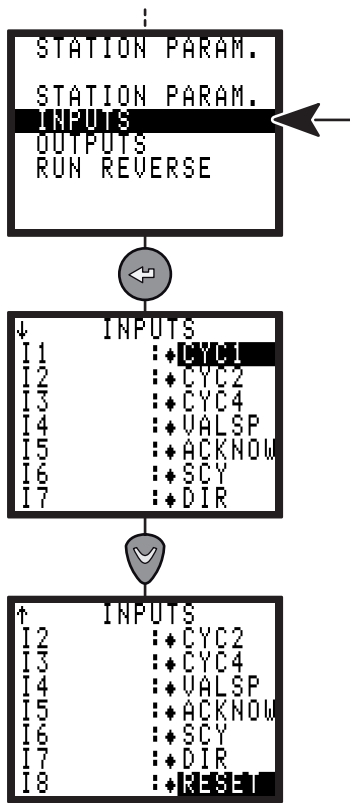

Do not change SCY and DIR settings.

Inputs	Name	Factory config.	Comments
Cycle 1 selection	CYC1	X	Binary coding - weight 1, i.e. from 0 to 1.
Cycle 2 selection	CYC2	X	Binary coding - weight 2, i.e. from 0 to 3.
Cycle 4 selection	CYC4	X	Binary coding - weight 4, i.e. from 0 to 7.
Cycle 8 selection	CYC8	X	Binary coding - weight 8, i.e. from 0 to 15.
Cycle 16 selection	CYC16		Binary coding - weight 16, i.e. from 0 to 31.
Spindle validation	SPVAL	X	Validates - or not - the tool start in both tightening directions if "Sp. val." is enabled in the Station Menu.
Tightening direction validation	VSPTIG		Validates - or not - the tool start in the tightening direction if "Sp. val." is enabled in the Station Menu.
Run reverse direction validation	VSPLOO		Validates - or not - the tool start in the run reverse direction if "SpV.rvv" is enabled in the Station Menu.  No effect in ECPHT mode.
Error acknowledgement	ACKNOW	X	Validates again the tool operation after a reject report if the error acknowledgement function in the Station Menu is enabled.
Start cycle	SCY	X	The cycle is run as long as the signal is at 1. When the signal drops, the cycle stops and the report is sent to the PLC.
Tightening / Run reverse	DIR	X	Validates the un-tightening direction as soon as the Start Cycle signal appears, at the speed programmed in the Station Menu and with the maximum current of the tool.
Reset	RESET	X	This signal resets the tightening reports and deletes the results displayed.
External stop	EXSTOP		When the parameter is programmed on Yes in the programming screen of the run down speed, final speed and run reverse phases, the system stops the current phase on a pulse and switches to the next one.

Inputs	Name	Factory config.	Comments
Synchronization	SYNC		Validates the synchronization of the tightening phases of several controllers (see "Synchronizing several CVIC controllers", page 50).

### 7.6.3.1 - PLC output, CVIC input wiring

Two configurations are available.

- The CVIC 24V is used as the Common of a PLC relay board.

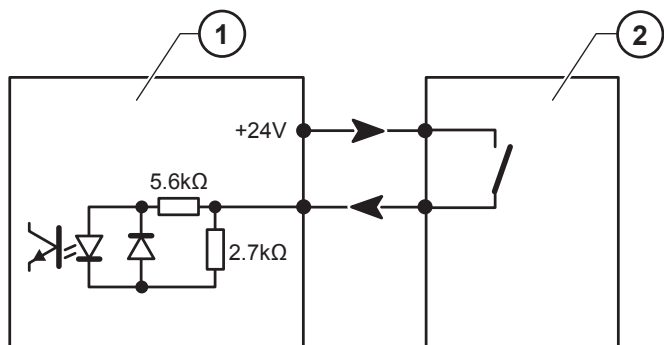

#### Legend

- 1 Controller input
- 2 PLC output

- By default, the PLC 24V is sent to the inputs of the controller.

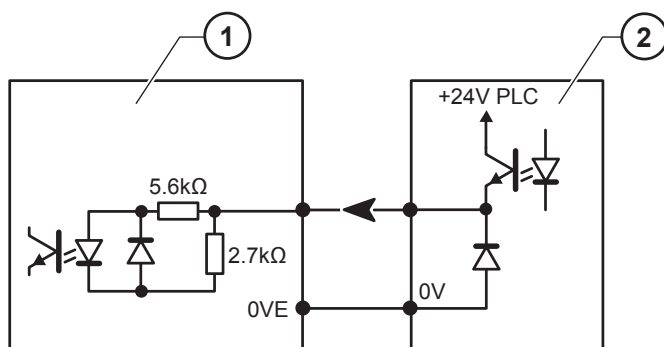

#### Legend

- 1 Controller input
- 2 PLC output

The inputs are type II as per standard CEI 1131-2 (24 V / 13 mA per input).

## 7.6.4 - OUTPUT menu

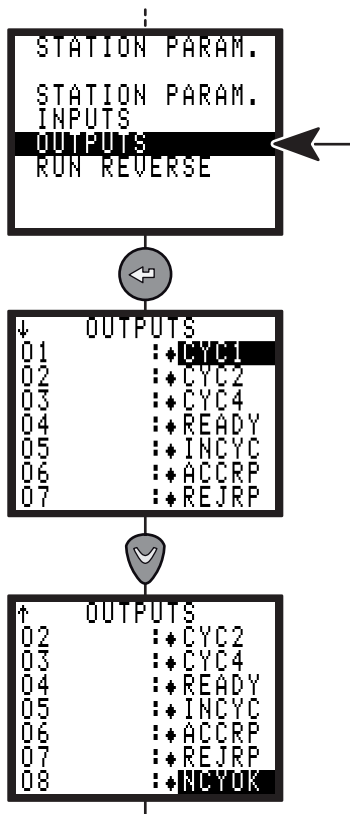

Outputs	Name	Factory config.	Comments
Cycle 1 acknowledgement	CYC1	X	Binary coding -weight 1. The cycle acknowledgement is sent back only if it corresponds to a programmed cycle; otherwise it is at "0".
Cycle 2 acknowledgement	CYC2	X	Binary coding -weight 2. The cycle acknowledgement is sent back only if it corresponds to a programmed cycle; otherwise it is at "0".
Cycle 4 acknowledgement	CYC4	X	Binary coding -weight 4. The cycle acknowledgement is sent back only if it corresponds to a programmed cycle; otherwise it is at "0".
Cycle 8 acknowledgement	CYC8	X	Binary coding -weight 8. The cycle acknowledgement is sent back only if it corresponds to a programmed cycle; otherwise it is at "0".
Cycle 16 acknowledgement	CYC16		Binary coding -weight 16. The cycle acknowledgement is sent back only if it corresponds to a programmed cycle; otherwise it is at "0".
Ready	READY	X	This signal is at "1" when the controller is in working order.
In cycle	INCYC	X	Response to the Start Cycle request. Drops to "0" at end of cycle.
Global report OK	ACCRP	X	Sent to the PLC when the cycle is over and the global report is OK.
Global report NOK	REJRP	X	Sent to the PLC when the cycle is over and the global report is NOK.
Number of cycles OK	NCYOK	X	This signal switches to "1" when the number of cycles run with an Accept report is equal to the programmed number of cycles OK. This output is reset after the "RP duration" time set in the "Station - general parameters" menu.
Synchronization	SYNC		The synchronization signal falls down at the end of the phase and is used, connected with synchronization of other controllers to synchronize the next phase (see "Synchronizing several CVIC controllers", page 50).
Torque report OK	TOROK		Sent to the PLC when the cycle is over and the torque report is OK.
Torque report NOK	TORNOK		Sent to the PLC when the cycle is over and the torque report is NOK.
Angle report OK	ANGOK		Sent to the PLC when the cycle is over and the angle report is OK.
Angle report NOK	ANGNOK		Sent to the PLC when the cycle is over and the angle report is NOK.

**7.6.4.1 - CVIC output, PLC input wiring**

Below are shown the two wiring configurations available for the relayed outputs of the CVIC.

- The PLC 24V is connected to the CVIC II output common. The PLC input do not receive external 24V.
- By default, the PLC 24V is sent to the inputs of the controller.

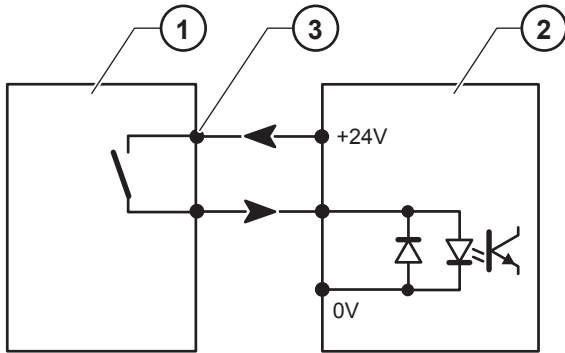

- Legend**
- 1 Controller output
  - 2 PLC input
  - 3 Common of the output relays

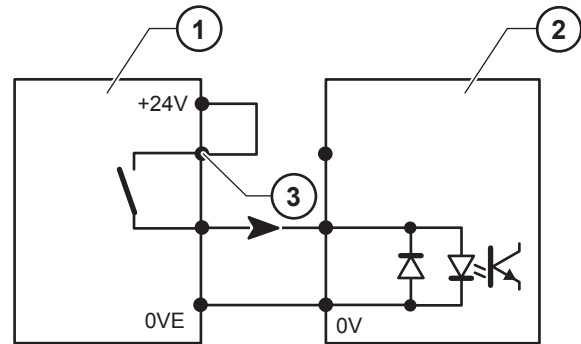

- Legend**
- 1 Controller output
  - 2 PLC input
  - 3 Common of the output relays

All outputs are enabled at 1 and relayed in the controller with a common point (4) for all outputs.

Features of the contacts: 1A / 30V / 30W max. DC on resistive charge.

**7.6.5 - REVERSE menu**

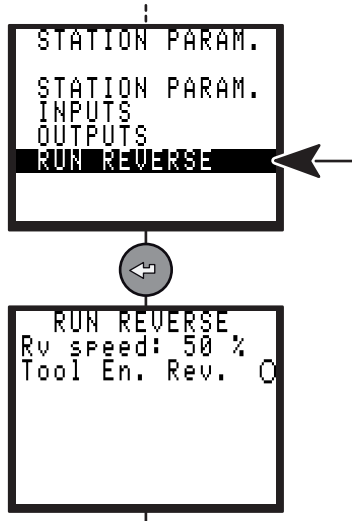

Screen name	By default	Comments
Rv speed	50%	This speed is used at each run reverse command by the operator (the run reverse speeds used during the cycle may be programmed in the run reverse phases or in the actions on NOK per cycle).
Tool En. Rev.	No	Yes / No Enable or disable the operator to perform a loosening operation. When No, the operator is allowed to perform loosening operation. When yes, the operator can't perform loosening operation unless the SPVALRV (spindle reverse validation) input is activated
Type	SpindleDir	SpindleDir : Reverse in opposite of the spindle way with default parameters. Last Phase : Reverse in opposite of the last tightening phase programmed in the current cycle. Use Cycle : Use a cycle programmed in the cycles list.

7.7 - PERIPHERALS menu

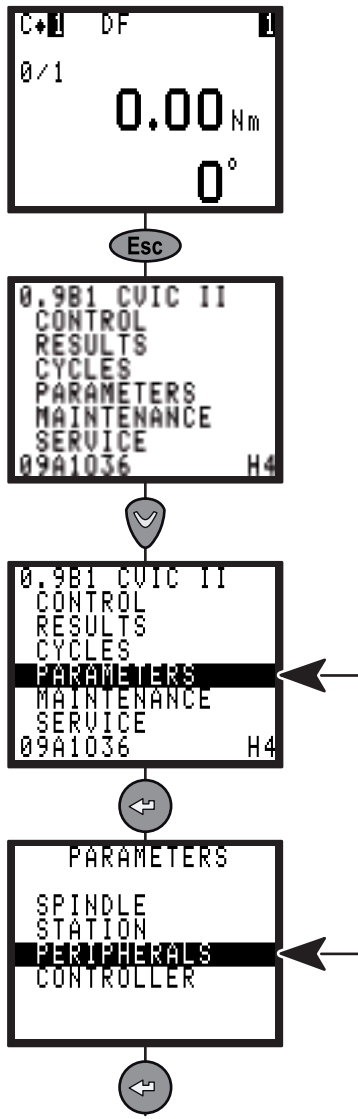

7.7.2 - ETHERNET CONFIGURATION menu

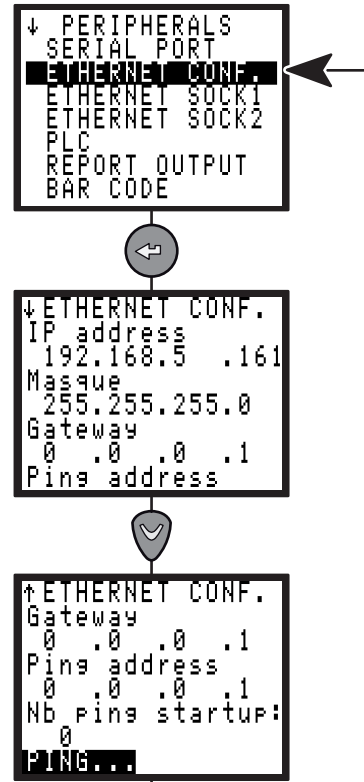

Parameter	Comment
IP Address	IP address of the controller in the network
Mask	In case of integrating the controller in an existing network, please contact your administrator to get the correct mask
Gateway	To be set when the network uses "Gateway"
Ping IP	IP address of another equipment connected to the controller
Nb ping startup	Starting the controller, execute several pings at the corresponding address

7.7.1 - SERIAL PORT menu

The serial port is used for the following functions:

- PC transfer (used to communicate with CVIPC 2000 software).
- Bar code and report output.
- Printing the results in order of occurrence (ASCII, use Bar code and report output selection).
- Automatic calibration with the DELTA measuring unit (no programming is required).

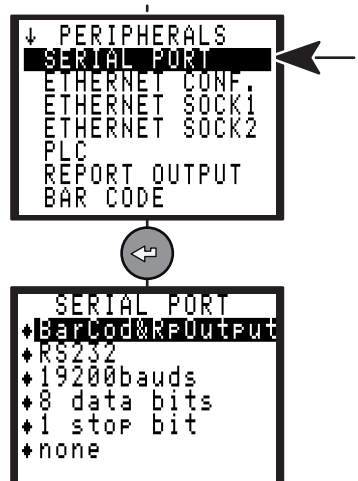

### 7.7.3 - ETHERNET SOCKET 1 menu

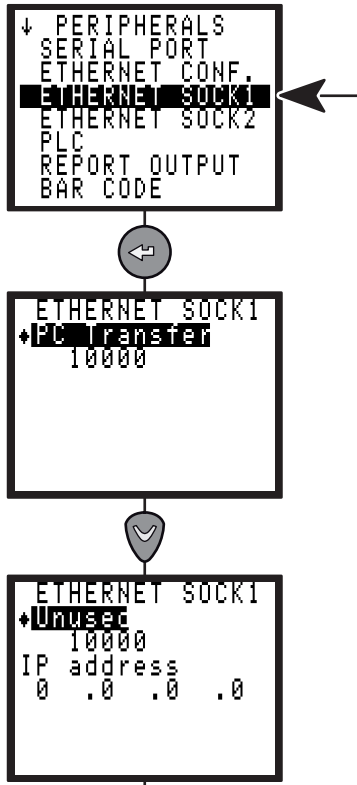

The ethernet socket 1 is used for the following function:

- PC transfer (used to communicate with CVIPC 2000 software)

### 7.7.4 - ETHERNET SOCKET 2 menu

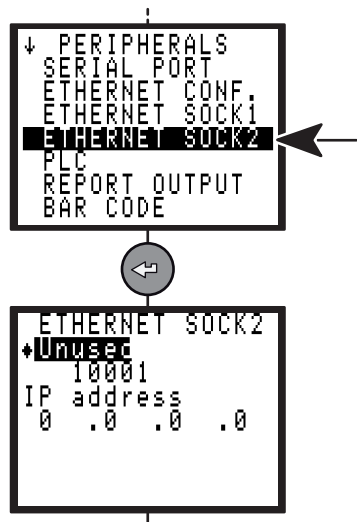

The ethernet socket 2 is used for the following functions:

- CVINET data collector
- ToolsNet data collector (this choice needs to get a license).

### 7.7.5 - PLC menu

To get the functionalities it is necessary to insert an optional fieldbus module.

The layout of the setting screens shall differ according to the inserted module.

#### 7.7.5.1 - Ethernet/IP module

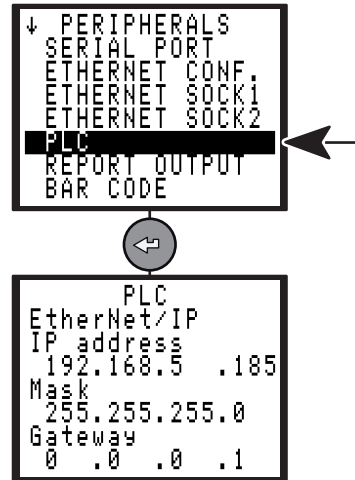

Parameter	Comment
<b>IP Address</b>	IP address of the controller in the PLC network (must differ from Ethernet address see "ETHERNET CONFIGURATION menu", page 39).
<b>Mask</b>	In case of integrating the controller in an existing network, please contact your administrator to get the correct mask.
<b>Gateway</b>	To be set when the PLC network uses "Gateway".



7.7.5.2 - Profinet IO module

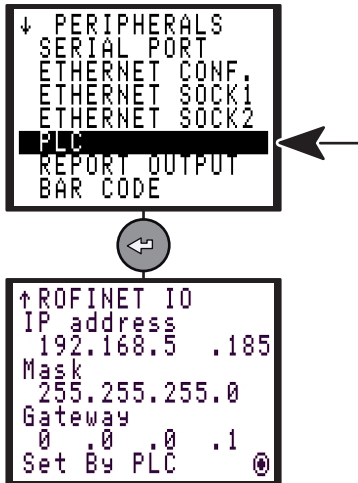

Parameter	Comment
IP Address	IP address of the controller in the PLC network (must differ from Ethernet address see "ETHERNET CONFIGURATION menu", page 39).
Mask	In case of integrating the controller in an existing network, please contact your administrator to get the correct mask.
Gateway	To be set when the PLC network uses "Gateway".
Set by PLC	Tick "Set By PLC" to have the IP address, mask and gateway set by the PLC.

7.7.5.3 - Profibus module

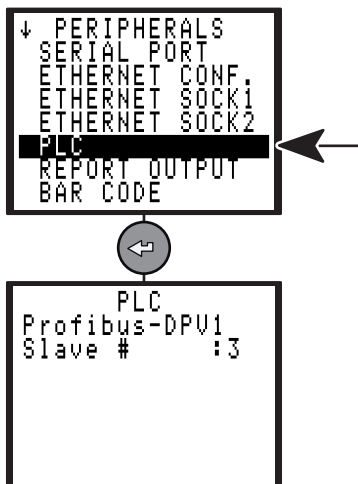

Parameter	Comment
Slave #	Slave number of the controller in the PLC network.

7.7.5.4 - CC-Link

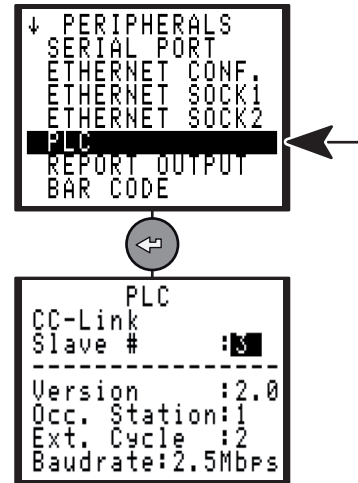

Parameter	Comment
Slave #	Slave number of the controller in the PLC network.

7.7.6 - REPORT OUTPUT menu

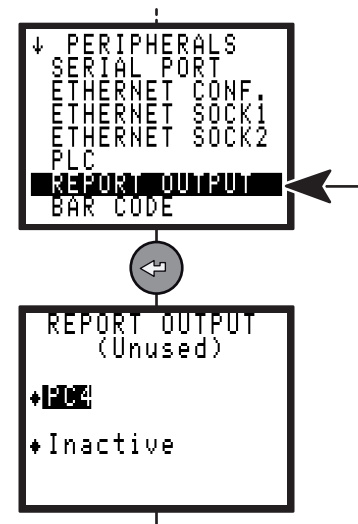

The report is printed according to the following parameters:

- Format: PC2 / PC3 / PC4 / Specific / PC5A / PC5B / PC5C.
- Upon request at end of cycle (See "Printing format for tightening results", page 52).

7.7.7 - BAR CODE menu

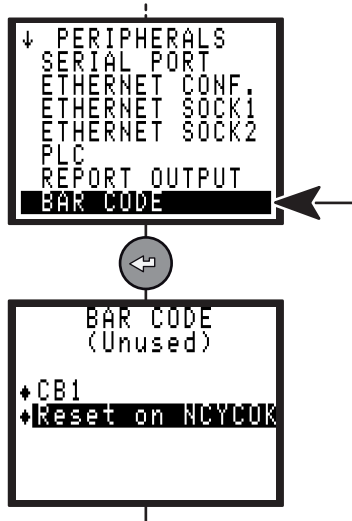

7.7.8 - CVINET menu

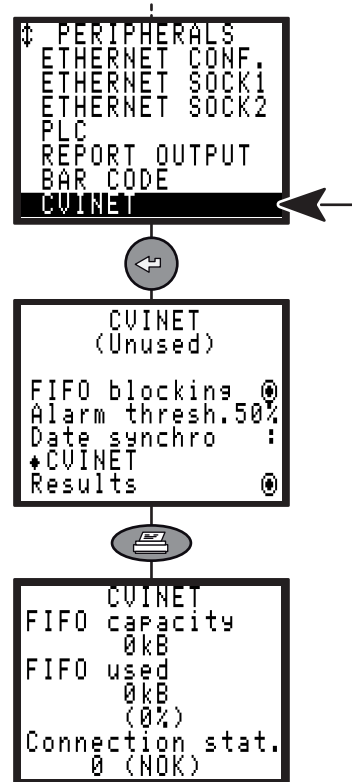

The bar code reader allows you to automatically select one of the cycles previously programmed in the controller.

To enable the barcode reader, you need to do the following:

- Declare the source of selection of the cycles as being the bar code.
- Configure the serial link:

Barcode function
9,600 bauds
8 data bits
1 stop bit
No parity

They cannot be programmed by the PC.

Set up the table of selection of the cycles according to the barcode numbers, which can be done only with the CVIS / CVIC PC2000 software.

As the barcode is read by the controller, it can perform one of the following actions:

Parameter	Comment
No action	No action is performed
Reset	Reading the code leads to an action which is identical to the Reset action.
Reset on NCYCOK	Reading the code leads to a Reset when the programmed number of cycles OK is reached

The CVINET software can be used to recover the tightening results on PC via Ethernet.

This screen is the configuration of the CVINET data collector.

Parameter	Comment
FIFO blocking	When the result memory to be transmitted is full, the start cycle that follows can be locked or not (the start cycle is not locked on, but next results are not saved).
Alarm thresh.	When the memory filling rate reaches this value (1 to 99%), an alarm is displayed.
Results	Tightening results
Date synchro	Choose how to update the machine on time (CVIPC / CVINET / CVIPC and CVINET).
FIFO capacity	Memory space allocated for not transmitted results
FIFO used	Memory space used in the FIFO
Connection status	NOK: not connected to the CVINET server. OK: connection established.

## 7.7.9 - TOOLSNET menu

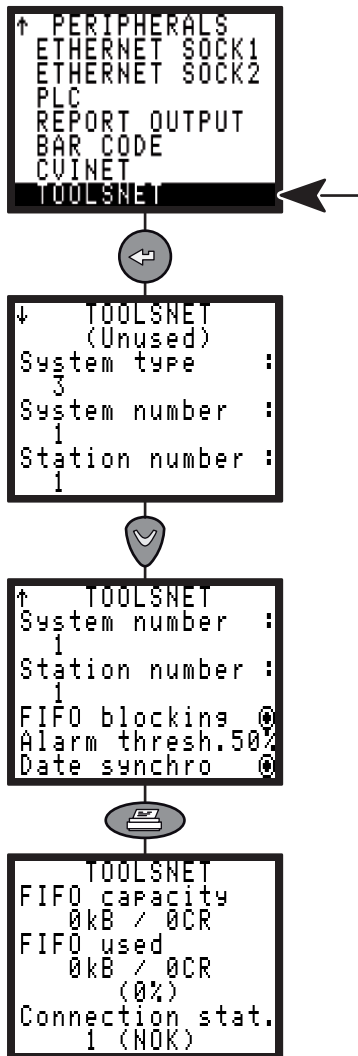



Parameter	Comment
<b>System type</b>	Type of system for ToolsNet server (3 is the default: OP Undefined controller)
<b>System number</b>	Identification of the system in the controller network (group of stations)
<b>Station number</b>	Identification of the station in the controller network (individual station)
<b>FIFO blocking</b>	When the result memory to be transmitted is full, the start cycle that follows can be locked or not (the start cycle is not locked on, but next results are not saved).
<b>Alarm thresh.</b>	When the memory filling rate reaches this value (1 to 99%), an alarm is displayed.
<b>Date synchro</b>	Check the box to synchronize the controller date with the ToolsNet server.
<b>FIFO capacity</b>	Memory space allocated for not transmitted results
<b>FIFO used</b>	Memory space used in the FIFO
<b>Connection stat.</b>	NOK: not connected to the CVINET server. OK: connection established.

The ToolsNet software can be used to recover the tightening results on PC via Ethernet.

This screen is the configuration of the ToolsNet data collector.

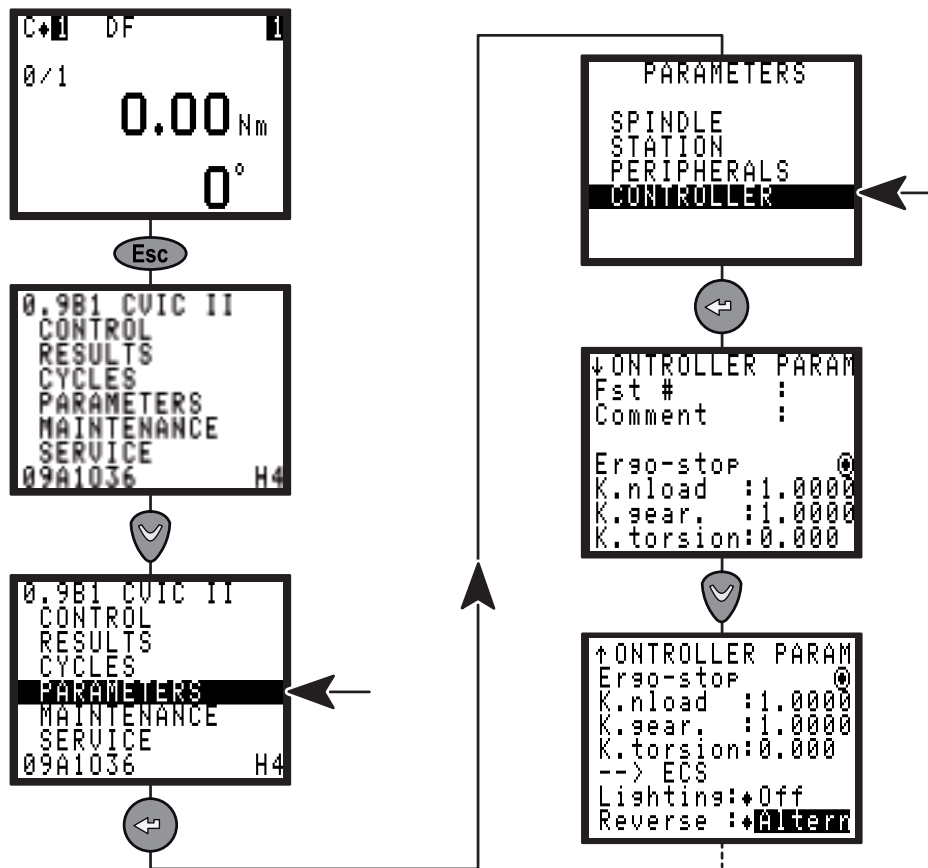
7.8 - CONTROLLER menu



Parameter	Comments
<b>Comment</b>	Possibility to add a comment up to 15 characters to identify the controller.
<b>Fst</b>	Possibility to add a comment or figures up to 3 characters to identify the fastener.
<b>Ergo-stop</b>	Activates or not the ergo-stop function at the end of the tightening operation. This reduces the reaction shocks at the end of the tightening and is recommended for portable tools.   No effect in ECPHT mode.
<b>K.nload</b>	Nominal load coefficient for use of external torque multiplier. Update torque calibration.
<b>K.gear</b>	Gear ratio coefficient for use of an external torque multiplier. Update angle calibration.
<b>K.torsion</b>	Torsion coefficient used in control angle strategies to compensate the mechanical torsion of the installation.
<b>Lighting</b>	For ECS tool only: time to switch off the front lights after no using (Off, 1, 2, 5, 10mn).
<b>Reverse</b>	For ECS tool only: modify the reverse mode: <ul style="list-style-type: none"> <li>• Altern: each pressure on the reverse button changes the direction of rotation of the tool.</li> <li>• 1 shot: a pressure on the reverse button activates the loosening and return automatically to normal direction at the next start.</li> <li>• 2 shot: 2 pressure on the reverse button activates the reverse mode.</li> <li>• Start: a pressure on the reverse button starts the tool in the loosening direction as long as the reverse button is activated.</li> </ul>

## 8 - MAINTENANCE

This section helps the maintenance operator to:

- Check that the controller + tool assembly operates correctly.
- Know the number of cycles run.
- Tune the system manually or automatically.
- Adjust the contrast of the display, update controller date, select the language and program an access code.
- Change the memory battery.
- Backup and restore the controller.

### 8.1 - MAINTENANCE menu

#### 8.1.1 - TEST menu

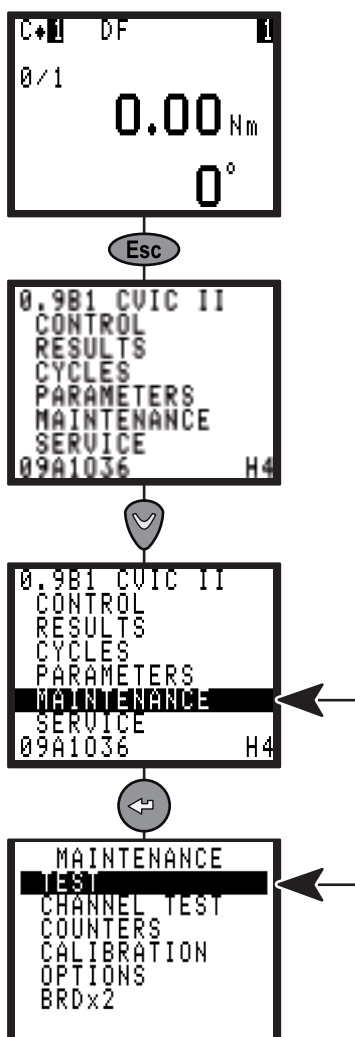

#### 8.1.1.1 - START SPINDLE menu

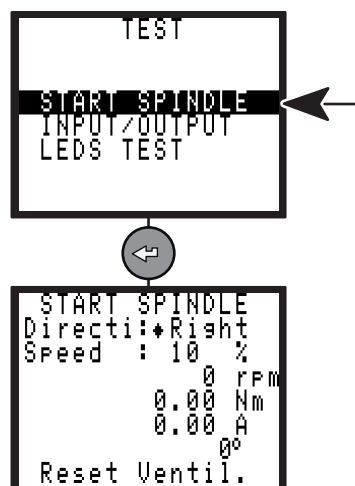

The START SPINDLE menu allows you to check the correct operation of the tool.

- Select the speed and rotation direction (Directi reverser for a hand held tool or in the menu for a fixed tool) then press the trigger for a hand held tool of EC type or press the On button for a fixed tool of MC or MCL type.
- Select Reset to reset the display.
- Select Ventil. to start the fan and check its working order.

#### 8.1.1.2 - INPUT / OUTPUT menu

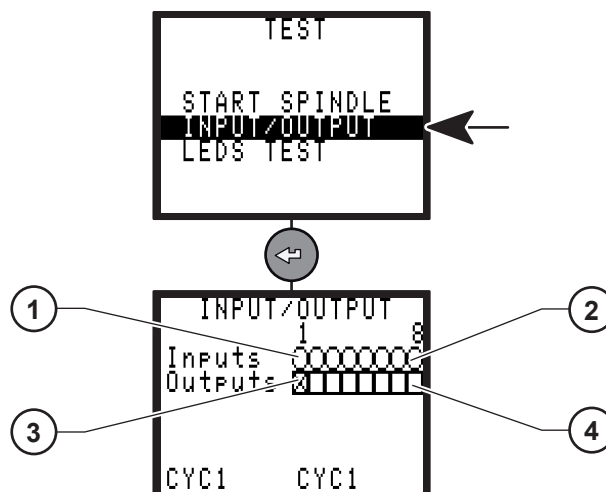

Legend

- 1 Input no 1
- 2 Input no 8
- 3 Output no 1
- 4 Output no 8

The INPUT/OUTPUT menu allows you to check the status of inputs and to test the outputs.

Testing the outputs:

- The cursor blinks on output 1 (3).
- Press to move the cursor.
- Press to validate the box or not.
- The selected output is or is not enabled.
- Then it is possible to check the efficiency of the status change of this output on the corresponding input, for example on the PLC.

8.1.1.3 - LEDS TEST menu

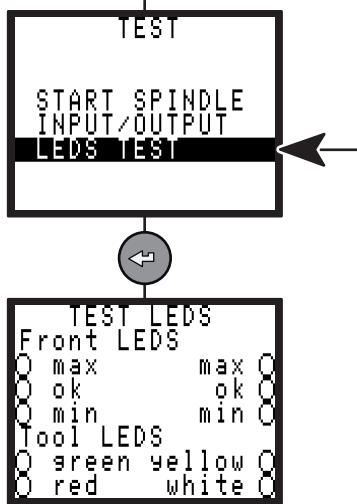

This menu allows for testing the LEDs located on the front side of the CVIC and for testing the LEDs on the tool.

8.1.2 - CHANNEL TEST menu

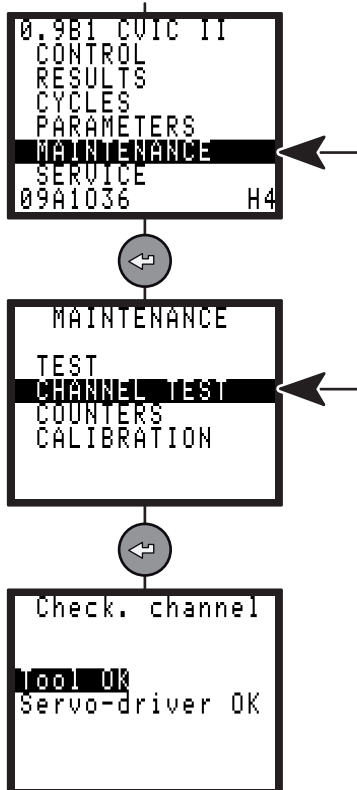

This menu is used to test the operation of the controller and tool. There is a sequence of two tests:

- Reading the information contained in the tool memory
- Checking the servo drive board.



**If an error arises, a message is displayed.**  
Press to display an additional error message.

8.1.3 - COUNTERS menu

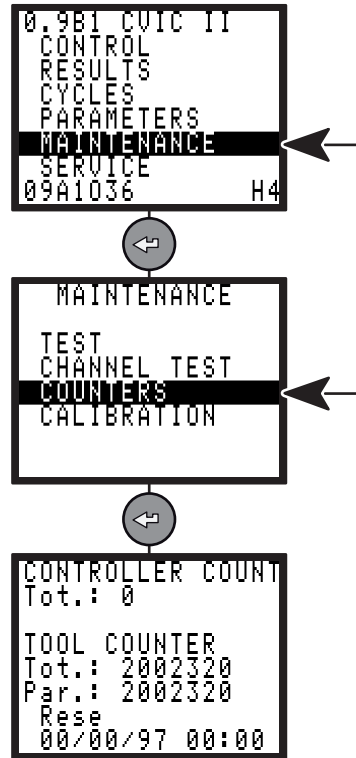

This menu allows the maintenance technician to know the number of cycles run.

- The Controller counter shows the number of cycles run since delivery.
- The Tot. (total) and Par. (partial) counters show the number of cycles run by the tool.
- Select Reset to reset the partial counter of the tool.

8.1.3.1 - Maintenance info screen

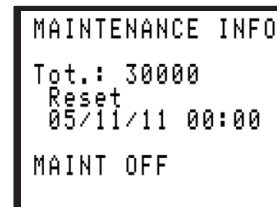

- MAINT OFF: maintenance is not reached yet.

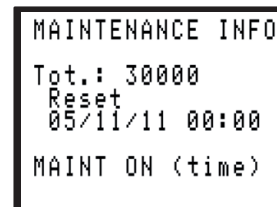

- MAINT ON (time): Maintenance is reached according to the selected date.
- MAINT ON (count): Maintenance is reached according to the tool counter.

### 8.1.4 - CALIBRATION menu

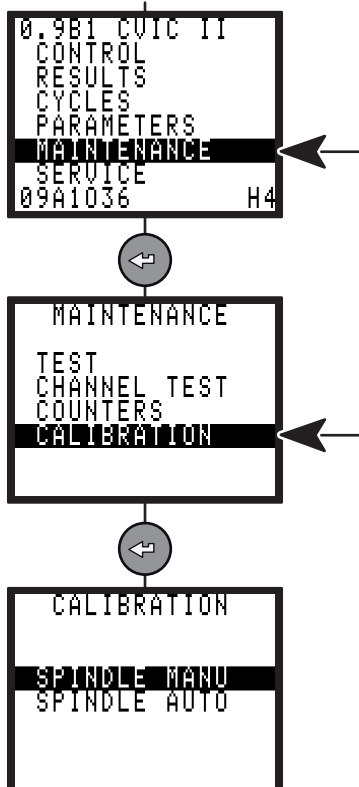

The calibration procedure is recommended to compensate for any possible drift of the tool torque or after each change of tool element.

#### 8.1.4.1 - SPINDLE MANU menu

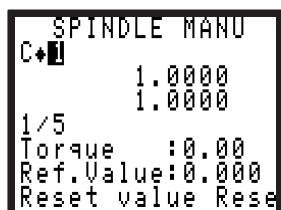

This menu is used to calculate and to apply a torque correction coefficient to the torque value of the selected cycle.

The torque transducer inserted in line with the tool can be connected to any measuring unit in the Desoutter range.

Run a tightening cycle 5 times and manually enter the values read on the standard instrument.

- The Reset value key resets the readings.
- The Reset coeff. key displays coefficient 1 by default.

Depending on the option selected (K Torque/spindle or K Torque/cycle) in the "STATION menu", page 31, the Torque correction coefficient is saved:

- Either in the tool memory.
- Or in the controller.



**The torque and angle reports MUST be correct to allow the procedure to be processed in normal conditions.**

#### 8.1.4.2 - SPINDLE AUTO menu

The target of this operation is to recalibrate completely the tool, for example after a motor change or a tool electronic change. This needs skilled operators.



**The tool will be tuned over its entire operating torque range.**

Equipment required:

- A torque measuring unit DELTA connected to the CVIC controller via a serial cable.
- The tool to be calibrated with a transducer and its cable.

Program the measuring unit by pressing / to display [standard] in the summary line, then to display [Calib CVIC].

Select the type of transducer to be used by pressing then / .

If the measuring unit is not correctly connected or programmed, an error message [Wait. for conn] is displayed on the screen.

Follow the instructions displayed on the CVIC screen.

10 tests can be run and they are performed at various increasing speeds.

Run one test after another.



**The tightening is performed up to the MAX torque.**

Press to validate the writing in the tool memory.

#### 8.1.4.3 - Calibration service

For full certified calibration, to cover your quality systems needs please consult your local Desoutter Customer Service Center that are fully prepared to support you, either at your site or in one of our workshops.

Being the equipment manufacture we are prepared not only to provide the calibration service and certification, but also to adjust your equipment for its fullest performance.

Our labs can provide you with either a local traceability chain to National standards or a International level, through ISO 17025 certified labs.

#### 8.1.5 - Options

Contact your Desoutter representative for support.

### 8.1.6 - BRDx2 - controller backup



The minimum software version of the controller must be: V 5.1.A9.

Use this device to clone a controller.

Both configuration and firmware are copied during the process.

Before restoring, check that the target controller is not connected to the same Ethernet network as the source controller as this may cause a conflict between IP addresses.

Connect the BRDx2 to the serial port of the controller as described in the user manual 6159922590.

Go to the Maintenance menu and select "BRDx2".

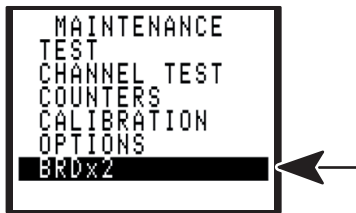

#### 8.1.6.1 - Backup

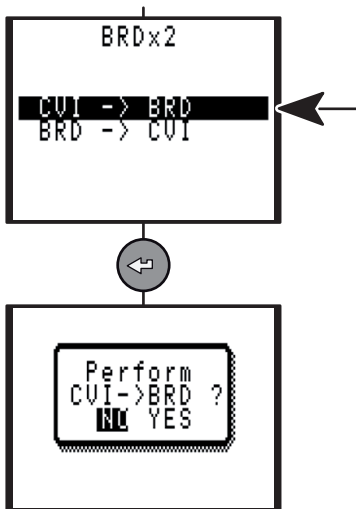

#### 8.1.6.2 - Restore

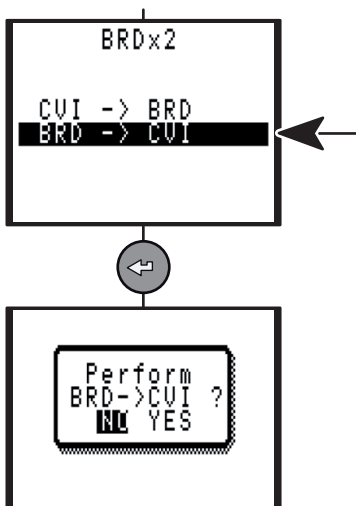

### 8.2 - SERVICE menu

See "Start up", page 12.

### 8.3 - Maintenance operation

#### 8.3.1 - Changing the memory battery

##### 8.3.1.1 - Memory battery connection

The memory battery allows you to save the parameters and results in of mains power failure.

A maximum lifetime of 10 years is indicated in the manufacturer's specifications.



For safety purposes, it is recommended to change the battery every 5 years.



Prior to any battery change, it is recommended to save the tightening program as well as the results, using the CVIS / CVIC PC2000 software.

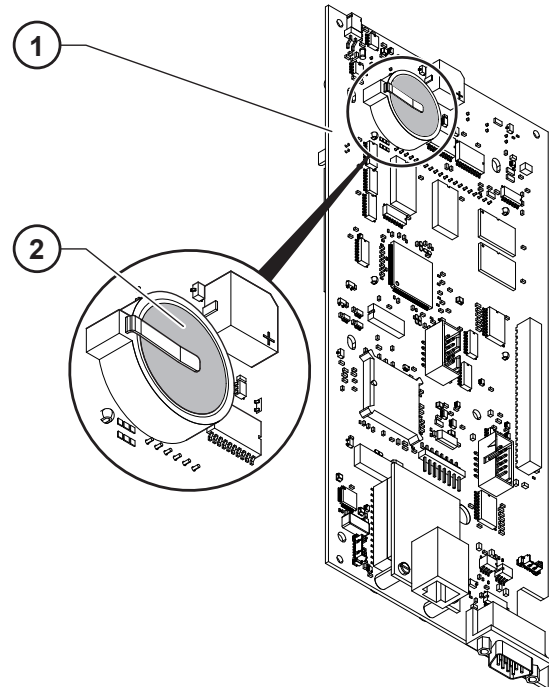

#### Legend

- 1 CPU board
- 2 Battery



#### ATTENTION

This procedure requires that the controller be disassembled and handled by certified technicians.

It also means that they should not be performed during warranty coverage or service contracts coverage, since it would void them.

Please consult your local Desoutter Customer Service Center, which have fully capable and trained engineers to perform any of your service needs in relation to the tightening system.



### 8.3.2 - Replacing the fan

The fan allows to cool down the controller.

A lifetime of 7 years in continuous operation is indicated in the manufacturer's specifications.

For safety purposes, it is recommended to change the fan every 5 years.

### 8.3.3 - Desoutter Tool and Account Services

The performance of your industrial tools directly affects the quality of your products and the productivity of your processes as well as the health and safety of your operators.

Please consult us on the "Tool Care" program that includes production support and maintenance solutions.

#### 8.3.3.1 - Tool Services

Our experts can keep your tools running at their best, reducing downtime and helping in making costs more predictable.

Thanks to our experience in power tools running in demanding applications all over the world, we can optimize the maintenance for each tool based on your application.

#### **Calibration**

To enable you to meet quality system criteria and pass audits, we offer a complete calibration service. With it you get scheduling, full management and traceable documentation. Properly calibrated equipment provides confidence that your products meet their highest performance and specifications.

#### **Installation & set-up**

Get new tools up and running faster with our installation and set-up services. A qualified Desoutter service engineer commissions new tools to specification. To save time, tools are optimized through simulation before they are shipped out for installation. They are then tested and their performance verified on-line. Based on application and joint analysis, the engineer tunes each tool for maximum reliability. Depending on the customer's need, our engineers can then provide a follow up of the production during the ramp up and final line speed. This ensures that the highest tightening capability is achieved at mass production levels.

#### **Repairs**

We reduce the administrative hassle of managing repairs, thanks to fixed price repair service and rapid tool turnaround. We always take advantage of the repair time to perform a complete overhaul, which helps tools to last longer on the production line, high uptime. For even faster turnaround, we can keep exchange parts in stock as part of your service contract. We can track the repair history of all tools, and we can provide extensively analysis report of the services provided, throughout the life of the tools.

### **Preventative Maintenance**

We customize, through our dedicated software, our preventative maintenance plan to your application requirements, taking into account parameters such as annual cycles, cycle times, torque settings and joint quality. This reduces ownership costs and keeps tools working at their best. Preventative maintenance is available with fixed pricing to help you manage your budget better. In some cases, tools maintained by us are eligible for extended warranties. We offer Extended Warranty Programs that provide a comprehensive service/support program for new tool purchases.

Please consult us on the "Tool Care" program that includes production support and maintenance solutions.

#### 8.3.3.2 - Account Services

In addition to optimizing the individual tool performance, we also help you simplify tool management and ownership.

#### **Training**

To improve the performance of your operators and the expertise of your line managers, we provide comprehensive training and seminar programs. We offer hands-on training at your plant or at one of our training centers. Training covers tool function and handling and includes torque adjustment, case and the basics of threaded fastener assembly. By improving the knowledge and skills of your operators, you will increase operator job satisfaction and productivity.

#### **Full service plans**

When managing a wide range of tool systems, it is important to keep costs under control. Our full service plans are tailored to your needs. They reduce spare part inventory, lower administration costs and provide budget predictability. Full service plans are available for single facilities or for multiple plants, whether in a single country, region or around the world. Desoutter will provide you with a full cost analysis and return of investment to ensure that you get the best optimization for taking care of your equipment. Take the challenge and let us demonstrate it to you!

Please consult us on the "Tool Care" program that includes production support and maintenance solutions.

## 9 - CONNECTIONS

### 9.1 - PC wiring diagram

- number 6159170470

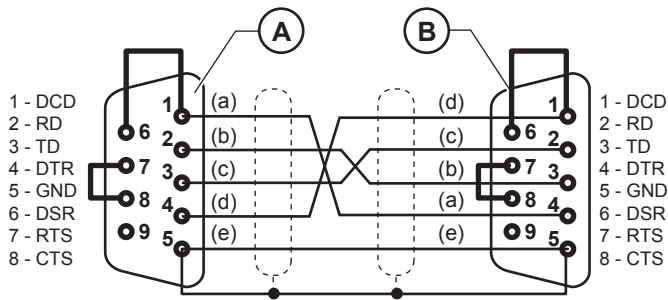

#### Legend

- A Sub D 9 contacts socket (PC side)
- B Sub D 9 contacts socket (Controller side)
- a White
- b Brown
- c Blue
- d Red
- e Black

### 9.2 - Synchronizing several CVIC controllers

To synchronize several CVIC controllers, you must:

- Allocate the "Synchro In" and the "Synchro Out" signals to unused inputs and outputs.
- Connect the controller Synchro signals and program a "Synchr. Waiting Phase" for each controller.



**The 0 VE of the I/O connectors of each controller are connected to each other. All other signals (cycle number, run...) must be connected to each controller.**

#### 9.2.1 - Example of connection diagram



It is necessary to wire a diode 1N4148 in serial with each synchro out signal.

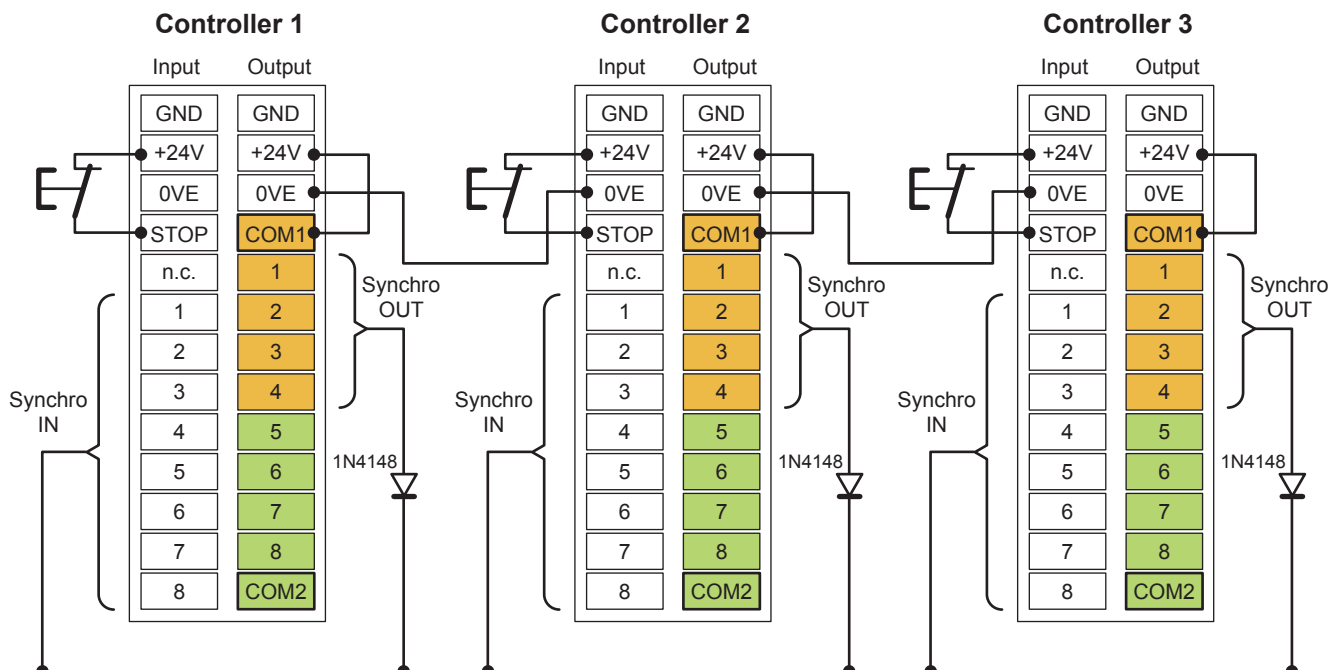

### 9.3 - Tool cables

#### 9.3.1 - EC cable

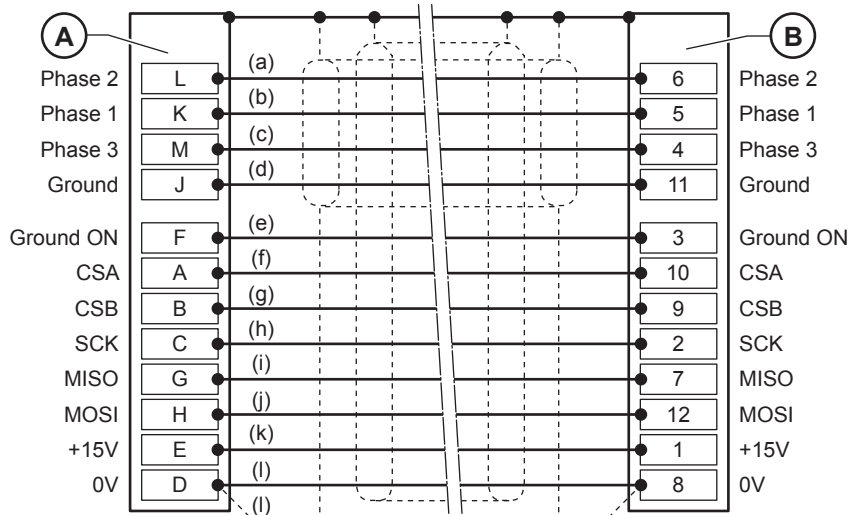

- Legend**
- A 12 point contact pin (Controller side)
  - B 12 point contact socket (EC side)
  - a White
  - b Red
  - c Blue
  - d Green / Yellow
  - e White / Purple
  - f Green
  - g Yellow
  - h Purple
  - i White
  - j Red
  - k White / Green
  - l Black

#### 9.3.2 - MC cable

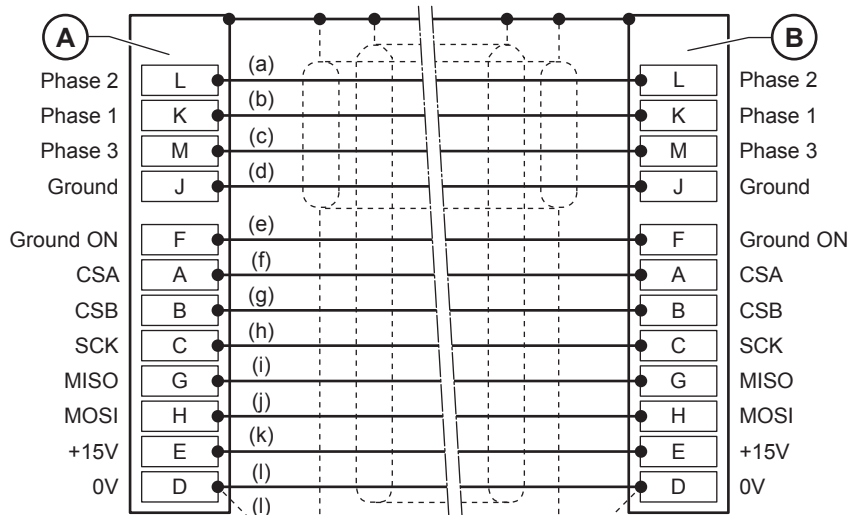

- Legend**
- A 12 point contact pin (Controller side)
  - B 12 point contact socket (MC side)
  - a White
  - b Red
  - c Blue
  - d Green / Yellow
  - e White / Purple
  - f Green
  - g Yellow
  - h Purple
  - i White
  - j Red
  - k White / Green
  - l Black

#### 9.3.3 - EC - MC extension cable

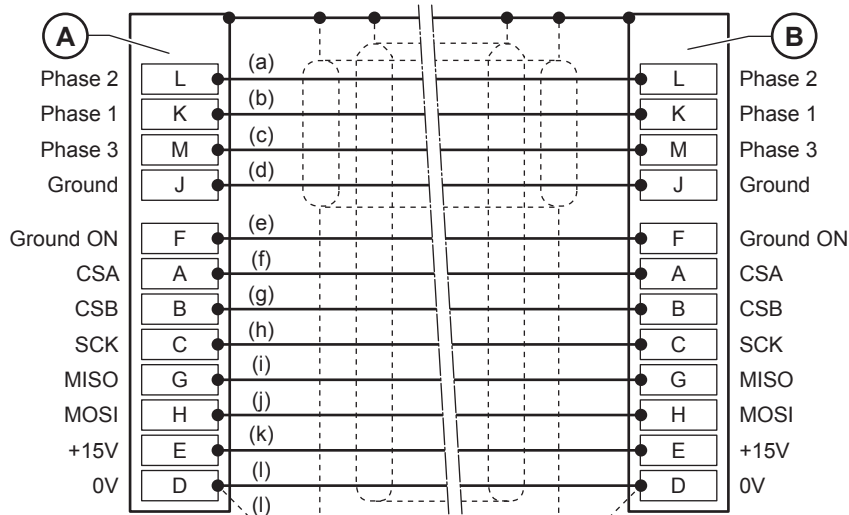

- Legend**
- A 12 point contact pin (Controller side)
  - B 12 point contact socket (Cable side)
  - a White
  - b Red
  - c Blue
  - d Green / Yellow
  - e White / Purple
  - f Green
  - g Yellow
  - h Purple
  - i White
  - j Red
  - k White / Green
  - l Black

## 10 - PRINTING FORMAT FOR TIGHTENING RESULTS

### 10.1 - PC2 format

Char number	Designation
1	char. <CR>
2	range or cycle number
2	fastener number
3	"T=+"
5	torque in 1/10 of Nm
1	<LF>
1	" "
1	<CR>
2	range or cycle number
2	fastener number
3	"A=+"
5	angle in 1/10 of degree
1	<LF>
1	" "
1	<CR>
2	range or cycle number
2	fastener number
3	
5	
1	<LF>
1	" "

Example of result:

```
<CR>0109T=+00400<LF> <CR>0109A=+01200<LF>
<CR>0109TR=+00580<LF>
```

The last result in the list ends with <LF><LF> instead of <LF>""

### 10.2 - PC3 format

Char number	Designation
1	char. A (frame type)
3	station number (1 to 250)
3	port number (1 to 32)
1	configuration (A to O correspond to configurations 1 to 15)
1	Z (system identifier)
1	char. A (frame type)
1	report code (see chart below)
6	date (year, month, day)
6	time (hour, minute, second)
8	torque
5	angle
1	<CR>
1	Checksum (modulo sum 256 of the previous characters) not calculated for the moment
1	<LF>

The last result in the list ends with <LF><LF> instead of <LF>

Report code: ASCII code 0100 :

①	②	③	④
X	X	X	X

Legend

- 1 1 = max. angle
- 2 1 = min. angle
- 3 1 = max. torque
- 4 1 = min. torque

According to the various combinations, the following characters will be obtained:

Character	Torque	Angle	Condition
@	accept torque	accept angle	If "NOK:SCY=0" is set to "Yes"
O	accept torque	accept angle	If "NOK:SCY=0" is set to "No"
A	min. torque	accept angle	
B	max. torque	accept angle	
D	accept torque	min. angle	
E	min. torque	min. angle	
F	max. torque	min. angle	
H	accept torque	max. angle	
I	min. torque	max. angle	
J	max. torque	max. angle	
0x00	on servodrive fault or spindle belonging to reject group or cycle start drop or cycle not completed for spindle or transducer fault		

Example of result:

```
A001001BZ@92120811021500041.7500121<CR>
<CS><LF>
```

## 10.3 - PC4 format

### 10.3.1 - Title

Char number	Designation (*)
XXXX	Rdg N°
XX	Sp
XX	Cy
XX	P
XX/XX/XX	Date
XX:XX:XX	Time
XXXXXX	Torque (Nm)
XXXXXX	Angle (dg)
XXXXXX	Torque rate (Nm/dg)
XXXXXX	Standby characters
XXXX	CR

(\*) depending on the language.

Example of result:

```
<CR>1223 01 03 01 18/04/03 09:03:45 0030.2
0120.50.5680 B <LF>
```

### 10.3.2 - Result

Char number	Designation
1	char. <CR>
4	Reading number
1	" "
2	Spindle number
1	" "
2	Cycle number
1	" "
2	Phase number (= 2 blanks if cycle result)
1	" "
8	Date in DD/MM/YY format
1	" "
8	Time in hh:mm:ss format
2	" "
6	Torque
2	" "
6	Angle
2	" "
6	Torque rate
2	" "
6	Stanby characters
2	" "
3	Report code in 3 letters
1	<LF>

In "Print at end of cycle" mode, the reading number is replaced by blanks.

If one of the values is missing in the unit (eg: torque rate), it is replaced by blanks.

Example of result:

```
<CR>1223 02 03 00 18/04/03 09:03:45 0030.2 0120.5
0.5680 B <LF>
```

### 10.3.2.1 - Report code

(See "Report codes", page 60).

The codes emitted on letters are used for digital report outputs or printouts.

All these codes correspond to specific displays.

The table below shows the corresponding codes displayed.

On the contrary, if some messages on the screen do not correspond to a letter, it means that they are not emitted.

Code emitted on 3 letters			Code displayed on the screen
1st Letter	2nd Letter	3rd Letter	
"A"			"Accept"
"R"			"R"
	"t"		"Tmin"
	"T"		"TMAX"
	"a"		"Amin"
	"A"		"AMAX"
	"G"		"Grou"
	"E"		"Time-Time"
		"V"	"Srv"
		"P"	"Prg"
		"S"	"Dcy"
		"I"	"Imax"
		"t"	"Time"
		"e"	"Ext"
		"_"	"_--"

**10.4 - PC5-A format****10.4.1 - Report per spindle: torque rate, torque, angle**

Char	Designation
<b>F0</b>	start of frame character
<b>01</b>	
<b>xx</b>	report (in hexadecimal notation)
<b>02</b>	
<b>xx</b>	00
<b>03</b>	
<b>xx</b>	AA angle report (*)
<b>04</b>	TT torque report (*)
<b>xx</b>	where TR, AA or TT =01 if low report
<b>05</b>	11 if accept report
<b>xx</b>	10 if high report
<b>06</b>	on servodrive fault
<b>xx</b>	spindle belonging to reject group
<b>07</b>	cycle start drop
<b>xx</b>	cycle not completed for spindle
<b>08</b>	transducer fault

(\*) in binary notation.

e.g.: if accept report for all the spindles:

**F0 01 3F 02 3F 03 3F 04 3F 05 3F 06 3F 07 3F 08 3F**

**10.4.2 - Reading results of spindle 1  
(x times the number of spindles)**

Char	Designation
<b>01</b>	spindle number
<b>xx</b>	
<b>xx</b>	applied torque (ASCII notation)
<b>xx</b>	e.g.:100.1 Nm
<b>xx</b>	30 31 30 30 31
<b>xx</b>	
<b>xx</b>	angle (ASCII notation)
<b>xx</b>	e.g.:40.0 °
<b>xx</b>	30 30 34 30 30
<b>xx</b>	
<b>xx</b>	
<b>xx</b>	
<b>xx</b>	
<b>xx</b>	
<b>xx</b>	
<b>xx</b>	
<b>xx</b>	
<b>FF</b>	end of frame character

**10.5 - PC5-B format****10.5.1 - Report per spindle: torque, angle, torque rate**

Char	Designation
<b>F0</b>	start of frame character
<b>01</b>	
<b>xx</b>	report (in hexadecimal notation)
<b>02</b>	
<b>xx</b>	00
<b>03</b>	TT torque report (*)
<b>xx</b>	AA angle report (*)
<b>04</b>	TR torque rate report(*)
<b>xx</b>	where TR, AA or TT =01 if low report
<b>05</b>	11 if accept report
<b>xx</b>	10 if high report
<b>06</b>	on servodrive fault
<b>xx</b>	spindle belonging to reject group
<b>07</b>	cycle start drop
<b>xx</b>	cycle not completed for spindle
<b>08</b>	transducer fault

(\*) in binary notation.

e.g.: if accept report for all the spindles:

**F0 01 3F 02 3F 03 3F 04 3F 05 3F 06 3F 07 3F 08 3F**



## 11 - TIGHTENING STRATEGY GUIDE

### 11.1 - Torque control

Torque control strategy is the most common use.

It offers the insurance that the torque has really been applied to the assembly but doesn't give the complete insurance that the assembly is correctly done.

For example the parts could be not tighten enough or not tighten at all when there is joint issues, i.e. "cross threads", missing washer, broken bolt, larger size of bolt; low quality bolt (even if the torque has been applied by the tool).

This strategy is selected when there is a wide angle dispersion and consequently it is not possible to detect the joint issues.

Some examples of joints:

- Drum washing machine
- Seat mechanism
- Outside rear mirrors
- Cooling/heating components

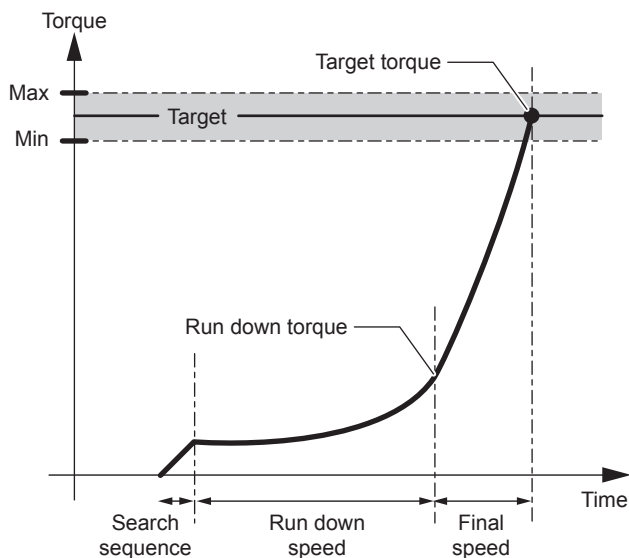

The recorded value is:

peak torque

#### Spindle stop

- IF torque  $\geq$  target torque

#### Accept report

- IF min. torque  $\leq$  peak torque  $\leq$  max. torque

#### Accept report with current monitoring (optional)

- IF min. torque  $\leq$  peak torque  $\leq$  max. torque
- AND min. current  $\leq$  final current  $\leq$  max. current

### 11.2 - Torque control and angle monitoring

Torque control strategy coupled with a torque and angle monitoring is adapted for most assemblies.

It offers:

- The insurance that the tightening operation is correctly done,
- A regular joint quality.

To reach this performance, we monitor the angle to detect joint issues, i.e. "cross threads", missing washer, broken bolt, larger size of bolt; low quality bolt.

In case of batch count, this strategy will detect any re-tightening of the bolt.

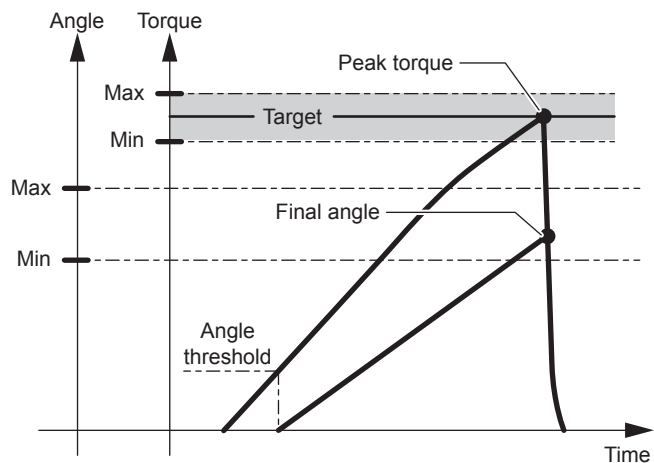

The start of the angle threshold counting should be within the linear area of the torque increase.

The angle measurement takes into account the torsion / back torsion of the spindle by measuring the angle during the torque drop phase, until the threshold value of the angle counting start is overstepped.

The recorded values are the following: peak torque and final angle.

#### Spindle stop

- IF torque  $\geq$  target torque
- OR angle  $>$  safety angle

#### Accept report

- IF min. torque  $\leq$  peak torque  $\leq$  max. torque
- AND min. angle  $\leq$  final angle  $\leq$  max. angle.



### 11.3 - Angle control and torque monitoring

For CVIC II this strategy allows to rotate by N degrees a bolt over the angle threshold.

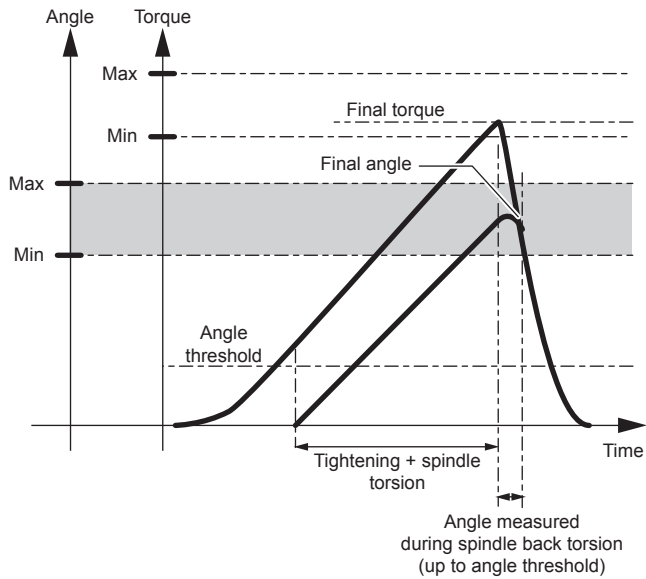

The recorded values are the following:

final torque and final angle

#### Spindle stop

- IF angle  $\geq$  target angle
- OR torque > max. torque

#### Accept report

- IF min. torque < final torque < max. torque
- IF min. angle < final angle < max. angle

### 11.4 - Prevailing torque control

This phase allows you to check the residual torque (prevailing torque) that results, for instance from the thread formed with tapping screws.

It is useful to know if the thread is formed correctly during the desired number of rotations without untimely locking or tapping deficiency.

The initial time out allows you to start the readings when the tool speed is stabilised.

The memorised result is the mean of the torque readings during the acquisition phase.

The system stops the acquisition of the torque and angle when the motor stops.

The torque pulse at the motor stop is not taken into account.

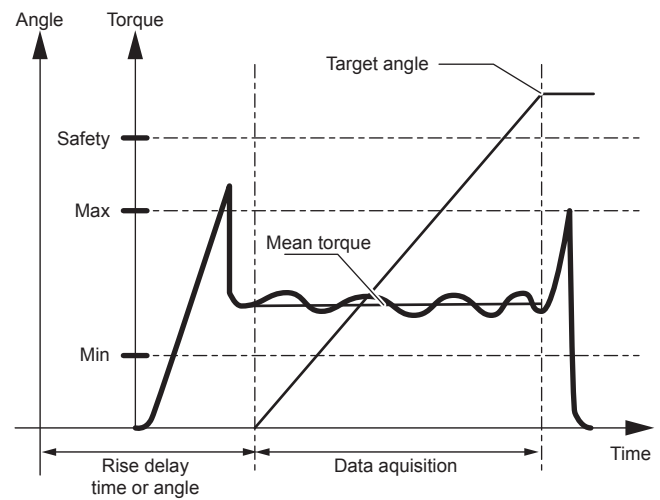

#### Spindle stop

- IF angle  $\geq$  target angle
- OR torque > safety torque

#### Accept report

- IF min. torque  $\leq$  torque  $\leq$  max. torque

## 11.5 - Loosening - torque control and angle monitoring

Loosening with torque control is used when you want to maintain small constraints in the assembly.

The un-tightening operation is not complete.

In addition to monitoring the untightening of the fastener, the system monitors the number of degrees reached while maintaining a residual torque in the fastener.

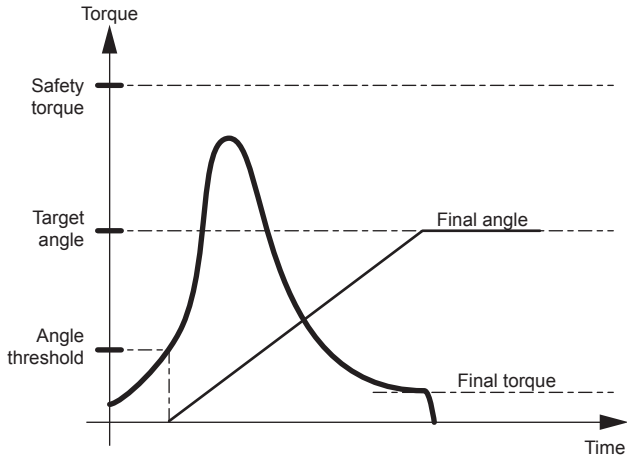

### Spindle stop

- IF torque  $\leq$  target torque
- OR torque  $>$  safety torque
- OR angle  $>$  max. angle

### Accept report

- IF torque  $<$  safety torque
- AND min. torque  $\leq$  final torque  $\leq$  max. torque
- AND min. angle  $\leq$  final angle  $\leq$  max. angle

## 11.6 - Untightening - angle control and torque monitoring

Loosening with angle control is mainly used to release the constraints in the assembly completely.

The recorded values are the following:

final torque and final angle.

### Spindle stop

- IF angle  $\geq$  target angle
- OR torque  $>$  safety torque

### Accept report

- IF torque  $<$  safety torque
- AND min. torque  $\leq$  final torque  $\leq$  max. torque
- AND min. angle  $\leq$  final angle  $\leq$  max. angle

## 12 - CYCLE FLOW CHART AND TIMING CHART

### 12.2 - Cycle timing chart

#### 12.1 - Cycle flow chart

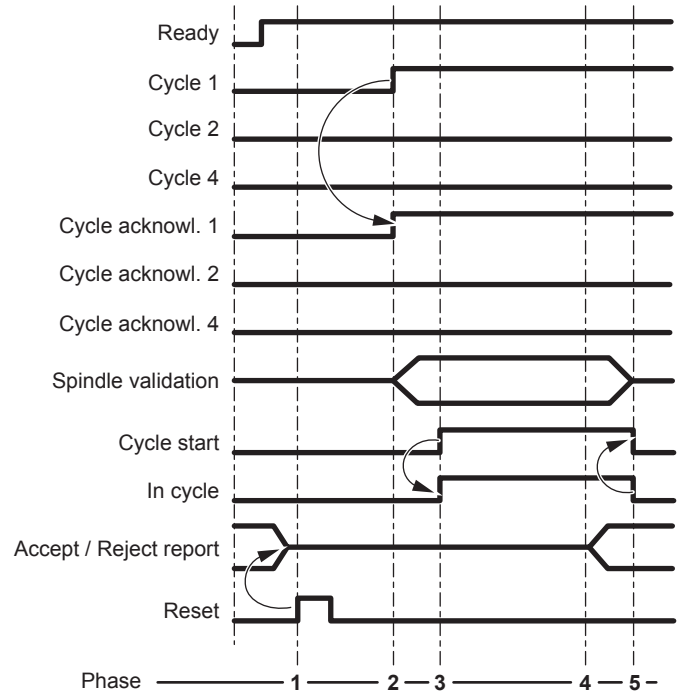
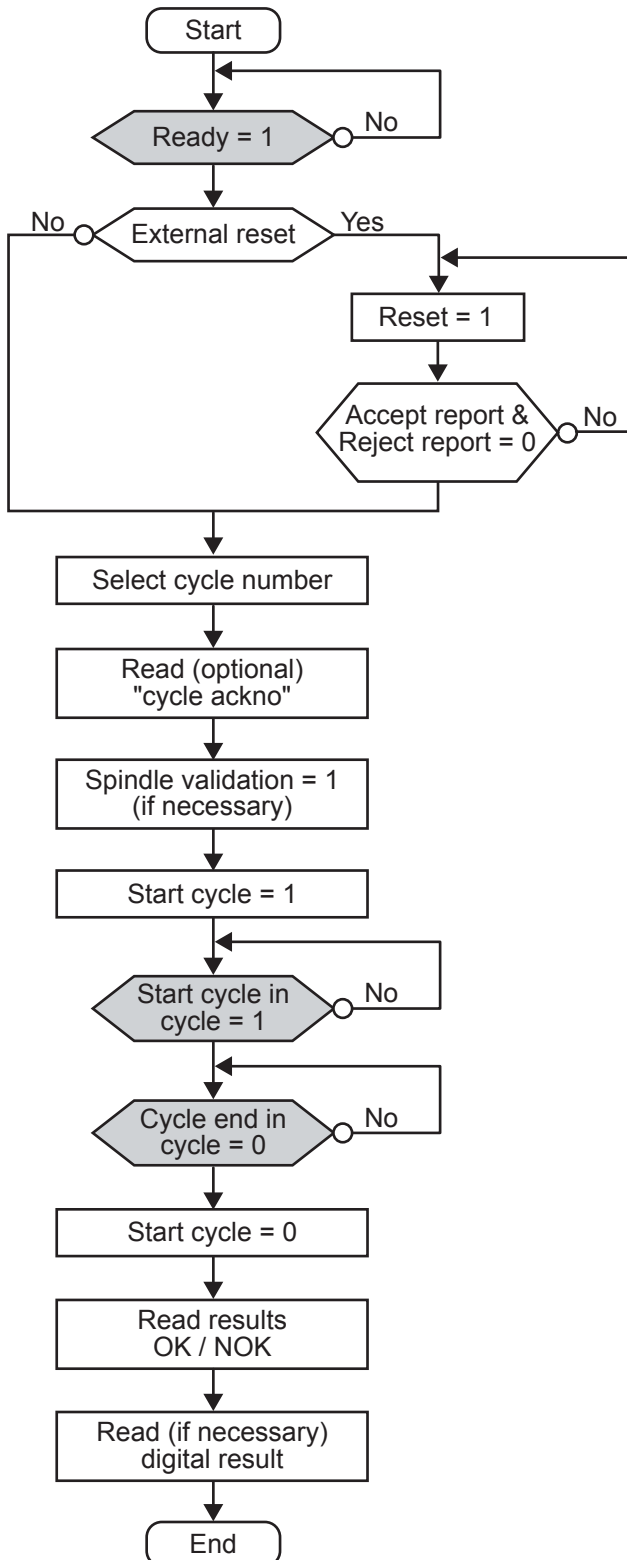

Phase	Designation
1	The Reset signal is sent by the PLC => resets the report (this PLC command is not compulsory).
2	The controller receives cycle n°1 => cycle acknowledgement n°1 is validated (if the cycle is programmed).
3	The controller receives the "Start cycle" => validates the "in cycle" signal.
4	At the end of the cycle, the controller validates an "accept" or "reject" report which is sent to the PLC.
5	The "in cycle" signal returns to zero when all the operations of the system are over.



To optimise cycle time, the PLC or digital control can be synchronised with the "accept report" or "reject report" signal, but the tightening system is ready to receive new commands (reset, etc.) only once the "in cycle" signal has been reset.

## 13 - TROUBLE SHOOTING HELP

### 13.1 - Warning

Choose one of these 2 methods to look for information in this document:

- Locate the error message(s) displayed on the screen of the controller among the messages listed in the document. A detailed explanation helps you understand the message(s). Cross-references leading to the error causes are suggested whenever this is possible.
- Select the relevant symptom among those listed. Each possible cause is numbered to make the search easier when cross-references are used.

### 13.2 - Report codes

Text	Comments
Accept	Accept report
Reject	Reject report
Tmin	The final torque at the end of the cycle is lower than minimum torque tolerance.
Tmax	The final torque at the end of the cycle is higher than the maximum torque tolerance.
Amin	The final angle at the end of the cycle is lower than the minimum angle tolerance.
Amax	The final angle at the end of the cycle is higher than maximum angle tolerance.
Scy	Cycle was aborted because the trigger switch was released prematurely. If it happens only just before reaching the target torque, torque and angle results may be within the programmed tolerances.
Time	Cycle was stopped after the time allocated for this phase or this cycle is elapsed and not by the target parameter. The programmed time out has to be modified to fit the application.
Err	 <p><b>ECPHT</b></p> <p>EITHER the tool or the programmed cycles are not consistent with the station mode(ECPHT/Normal). You can try the following:</p> <ul style="list-style-type: none"> <li>• Make sure the station mode is set correctly, according to the tool.</li> <li>• Go back to the cycle parameters and save it again, so that the station mode used for the cycle is the current running one.</li> </ul> <p>OR the speed is not constant when the torque is reached. Torque measurement is cancelled during speed transitions. This message mainly appears in case of hard joints. You can try the following adjustments:</p> <ul style="list-style-type: none"> <li>• Reduce the final speed to increase the phase time (remain &gt; 3%).</li> <li>• Reduce final speed phase acceleration time to minimum (0.01 s) to reach the tightening speed as quickly as possible.</li> <li>• Reduce the run down speed phase to avoid high over torque when clamping and to limit the speed gap between the run down and final speed phase.</li> </ul> <p>If the Err message remains, it means that the joint is too hard to change the speed after clamping. Try to program a new strategy: Angle run down + Final speed phase. As the run down phase must end before clamping, the speed transition between the 2 phases no longer needs to be rapid (0.3 s is sufficient).</p>

Text	Comments
<b>NOT READY</b>	<p>List of errors preventing the CVIC from being ready:</p> <ul style="list-style-type: none"> <li>● Over-current: Maximum servo drive current is reached.</li> <li>● Differential: Earth ground connection opened (the CVIC does not check earth linkage). This error is often due to a cable problem.</li> <li>● Thermal contact: Maximum motor temperature is reached (100°C). This error remains activated until the motor temperature falls below 80°C.</li> <li>● SPI link error: The cycle was aborted due to a digital communication problem (SPI) between the controller and the tool.</li> <li>● FLEX version error.</li> <li>● Maximum current (Imax).</li> <li>● Resolver: Position change or non zero speed detected when the motor start is not activated.</li> <li>● Temperature: Power components over temperature.</li> </ul>
<b>Svr</b>	<p>The cycle was aborted following a Servo drive error:</p> <ul style="list-style-type: none"> <li>● Over-current: The maximum servo drive current is reached.</li> <li>● Differential: The earth ground connection is opened (the CVIC does not check earth linkage). This problem is often due to a cable problem.</li> <li>● Thermal contact: The maximum motor temperature is reached (100°C). The error is activated as long as the motor temperature does not fall below 80°C.</li> <li>● SPI link error: The cycle was aborted due to a communication problem through the digital link (SPI) between the controller and the tool.</li> <li>● FLEX version error (FLEX)</li> <li>● Maximum current (Imax)</li> <li>● Resolver: Position change or non zero speed detected when the motor start is not activated.</li> <li>● Temperature: Power components over temperature.</li> </ul> <p><i>NOTE: All these errors deactivate the READY signal as long as the error exists.</i></p>
<b>Over current</b>	<p>Maximum servo drive current is reached. In this case, the motor cannot start again. Overall, it induces a Servo drive error, then a detailed Over-current error.</p>
<b>Differential</b>	<p>Earth tool connection fault (the CVIC doesn't check earth linkage). This error is often due to a cable problem. Overall, it induces a Servo drive error, then a detailed Differential error.</p>
<b>Thermal contact</b>	<p>Maximum motor temperature reached (100°C). The fault is activated as long as the motor temperature doesn't fall below 80°C again. Overall, it induces a Servo drive error, then a detailed Thermal contact error.</p> <p> <b>WARNING: When in MAINTENANCE \ TEST \ START SPINDLE mode, this error does not prevent the motor from working.</b></p>
<b>General</b>	<ul style="list-style-type: none"> <li>● Over-current: The maximum servo drive current is reached OR</li> <li>● Differential: The earth ground connection is opened (the CVIC does not check earth linkage). This problem is often due to a cable problem OR</li> <li>● Thermal contact: The maximum motor temperature is reached (100°C). The error is activated as long as the motor temperature does not fall below 80°C.</li> </ul>
<b>SPI link</b>	<p>The cycle was aborted following a digital (SPI) link fault between the controller and the tool. This fault removes instantaneously the READY signal of the machine (it is checked every 10 ms). Overall, it induces a Servo drive error, then a detailed SPI error.</p> <ul style="list-style-type: none"> <li>● When in the Checking channel menu we get: <ul style="list-style-type: none"> <li>- Tool error : Tool link (EEPROM)</li> <li>- Servo drive error</li> </ul> </li> <li>● When in START SPINDLE mode the motor is stopped.</li> <li>● When in TEST and CURRENT CALIBRATION mode: no action.</li> </ul>

Text	Comments
<b>FLEX version</b>	The FLEX software version is lower than the one necessary for the application version. This fault can only appear after a software upgrade. Nevertheless, the delivered software automatically upgrades the FLEX software version. When this fault occurs: <ul style="list-style-type: none"> <li>• It is not possible to start the motor in Normal mode.</li> <li>• It is possible to start the tool in Test mode.</li> <li>• It is possible to calibrate the tool manually or automatically.</li> <li>• It is possible to adjust the resolver offset.</li> </ul> Overall, it induces a Servo drive error, then a detailed FLEX version error.
<b>Imax</b>	The cycle was aborted because the maximum tool current is reached. This over consumption may also be due to short-circuit, a cable fault, a resolver fault or an offset resolver fault.
<b>Reading EEPROM</b>	Indicates an access error to the tool's EEPROM memory: <b>Writing</b> When one of the following operations is wrongly carried out: <ul style="list-style-type: none"> <li>• Log out / Data writing / Data re-reading / Data recorded comparison</li> </ul> <b>Reading</b> When switched on, the CVIC carries out a complete memory check <ul style="list-style-type: none"> <li>• CRC of the parameters: TOOL PROGRAMMING ERROR</li> <li>• Parameter version: TOOL VERSION ERROR</li> <li>• Parameter changing: CHANGE OF TOOL</li> <li>• Counter CRC: TOOL PROGRAMMING ERROR</li> <li>• Tool cycle CRC: TOOL PROGRAMMING ERROR</li> <li>• Cycle 0 CRC: TOOL PROGRAMMING ERROR</li> <li>• Torque/Current table CRC: TOOL PROGRAMMING ERROR</li> <li>• Controller/Tool compatibility: CURRENT TRANSDUCER INCOMPATIBLE WITH TOOL</li> </ul>
<b>Resolver</b>	Position change or non zero speed detected when the motor start is not activated. Only checked in Test mode.
<b>Temperature</b>	Indicates power components (IGBT) over temperature. The temperature is measured on the power components' cooling radiator. When the temperature exceeds 70°C, the error is activated and remains until the temperature returns below 65°C. Note that this measure also starts the internal fan from 60°C onwards and stops the fan when the temperature returns below 50°C. Overall, it induces a Servo drive error, then a detailed Temperature error.
<b>Prg</b>	The cycle was aborted due to a programming fault. For example: the programmed torque is higher than the tool capacity.
<b>Ext</b>	The cycle was aborted due to activation of the EXTERNAL STOP signal (if this option is selected in the concerned phase).
<b>Tool programming</b>	Tool memory parameters are wrong.
<b>Tool version</b>	The tool memory parameter version is not compatible with the CVIC software version.
<b>Tool link</b>	Tool memory parameter reading is impossible.
<b>Current transducer incompatible with tool</b>	The connected tool is not compatible with the CVIC model (e.g.: ECA60 connected to CVIC-2).
<b>E02</b>	Controller busy (for example: down-loading or up-loading in progress).
<b>E03</b>	Batch of cycle complete (number of cycles OK) if the Lock on NCYOK box (lock after a batch of cycle complete) in the STATION menu is activated.
<b>E04</b>	No cycle number validated on controller OR non-existing cycle number requested on the I/O port. A question mark is displayed on the screen.

Text	Comments
E05	<p>Spindle is idle on a start signal. No Spindle validation signal on the I/O port if the Spindle validation box is activated in the STATION menu. Tool will run only if the Spindle validation signal is activated on the I/O port.</p> <p>The cycle is aborted during the cycle. The cycle is stopped when the "Spindle validation" is cleared during the cycle. Pre-requisite: the "Spindle validation" is enabled with the parameter "Stop sp En=0". Refer to the "Station" chapter for more information.</p>
E06	Start cycle arrives when the controller is not ready (may be due to a tool change, a Servo drive error, etc. that has not been reset).
E07	<p>Spindle is disabled after a Reject report. If the Stop on bad report box in the STATION menu is activated, then the tool will be disabled. To enable it, it is necessary to activate the Failure acknowledge input on the I/O port.</p>
e09	<p>CVINET FIFO is full. The cycle can start but there is no free memory space left in the FIFO. Problem with the Ethernet connection or configuration may be the cause.</p>
E09	<p>CVINET FIFO is full. The cycle can not start because the Locking on when FIFO is full option is validated and there is no free memory space left in the FIFO. Problem with the Ethernet connection or configuration may be the cause.</p>
E10	<p>Report acknowledgement. The tool does not start when this error is present. If the "Report acknowledgement" parameter of the station menu is activated, the cycle start is inhibited. To release the tool start, send a "rising edge" to the "Request Report" signal on the input port.</p>
e12	<p>ToolsNet FIFO is full. The cycle can start but there is no free memory space left in the FIFO. Problem with the Ethernet connection or configuration may be the cause.</p>
E12	<p>ToolsNet FIFO is full. The cycle can not start because the Locking on when FIFO is full option is validated and there is no free memory space left in the FIFO. Problem with the Ethernet connection or configuration may be the cause.</p>

**13.3 - Operating problems due to adjustment problems**

Symptoms	Possible causes	N°	Check
The tool starts then stops immediately without running the rundown speed cycle.	The "stall torque" instruction is too low. The programmed current is too low. The acceleration time is too short compared to the maximum time. The maximum time is too short or null.	01	Check the values programmed for the run down and final speed sequences.
	A machine part impedes the rotation of the tool.	02	Please contact your local Customer Center.
The tool skips the rundown sequence.	The "current" instruction is too low. The acceleration time is too short. The rundown instruction is too low. The maximum rundown time is too short. The spindle is not validated in the sequence.	03	Check the values programmed for the run down sequence.
Seen from the controller side, the tool does not reach the programmed torque or hardly reaches it.	The power programmed during the relevant phase is not sufficient.	04	Check and increase the programmed value if necessary.
	The tool is not suited to the task.	05	Check that the tool performances are compatible with the required torque.
Dispersion or abnormal deviation in the tightening results.	The rundown torque is too high as compared to the final torque.	06	Check the torque rise curves. Reduce the speed of the tool in case of hard joints. Check the value of the rundown torque: The recommended value is close to a quarter of the final torque.
	The deceleration between the rundown phase and the final phase is too slow.	07	Reduce the transition interval between the rundown and tightening phases.
	The tightening speed is too high; the consequence of inertia is the significant overstepping of the set value.	08	Reduce the speed of the tightening phase. The technology of electric motors equipped with a "resolver" allows the speed reduction up to 1 % of the maximum speed of the tool. In most case, a rotation of 20rpm will be the best compromise.
The torque displayed by the controller is far from the actual torque.	The coefficient of the tool nominal load has been updated by mistake.	09	This coefficient should be equal to 1, except in the case of additional reduction gears. Check its value in the "Parameter/Tool" menu.
The torque value is constantly equal to 0; there is no error message.	The coefficient of the tool nominal load has been set to 0 by mistake.	10	This coefficient should be equal to 1, except in the case of additional reduction gears. Check its value in the "Parameter/Tool" menu.



Symptoms	Possible causes	N°	Check
The angle displayed by the controller is different from the actual angle.	The gear ratio coefficient of the tool has been updated by mistake.	<b>X1</b>	This coefficient should be equal to 1, except in the case of additional reduction gears. Check its value in the "Parameter/Tool" menu.
	The angle threshold programmed on the controller is different from the one programmed on the reference torquemeter	<b>X2</b>	Program the same angle threshold on both the controller and the reference torquemeter.
	In case of angle tightening strategy, the difference can be caused by the torsion of the shaft. It can cause an error of a few degrees	<b>X3</b>	With an Angle tightening strategy, it is possible to compensate the error due to the torsion of the shaft by modifying the torsion coefficient (by default: 0.00°/Nm).
	In case of angle tightening strategy, The torsion coefficient was modified by mistake	<b>X4</b>	Correct the torsion coefficient. See X3.

## 13.4 - Operating problems due to wear or breakdown

Symptoms	Possible causes	N°	Check
The tool does not start whether in tightening, or run reverse mode. The screen is idle.	The controller is switched off	11	Check: <ul style="list-style-type: none"> <li>The condition of the On/Off switch of the controller.</li> <li>That the mains voltage on the input side of the controller is not null.</li> <li>The condition of the controller fuses.</li> </ul>
MESSAGE: E01	Missing Emergency stop connector or emergency stop button engaged.	13	Check for links in the emergency stop connector and check that the emergency stop button is not engaged.
MESSAGE: "Tool fault"	The electrical links between the controller and the tool are faulty.	14	The cable(s) is (are) not connected. The connectors are insufficiently screwed or inserted. There are twisted contacts or contacts pushed back in one of the connectors. Check the continuity and insulation of every electrical link in the cables; change them if necessary.
	The message "Tool fault" is displayed when an unsupported tool is connected at the start-up of the firmware.		Change the tool.
Tightening report: "Srv"	Insulation defect, stop induced by the differential circuit-breaking	15	Check that the "Differential" message is displayed correctly by pressing the Enter key twice. In that case, look for the insulation defect: it could be in the tool (motor), in the cable or in the controller.
No error message, no rotation of the tool.	The tool trigger is faulty	16	Check that the cycle starts: a report is generated. In the "Maintenance - Inputs/Outputs" menu, check the switching of input no. 6. If there is a fault, test the switch between 6 and D in the tool connector ( $\delta \sigma \lambda$ ).
MESSAGE: "not ready" (blinking) (Control menu) or "servo-drive error" (Channel Test menu)	Servo-drive not ready: Open thermal contact. Could also result from a resolver fault or a resolver link fault	17	Check the condition of the "thermal contact" LED on the front side of the servo-drive. If the LED is lit, check the motor temperature and the connections (if necessary).
MESSAGE: "Trd"	The transducer values measured are above the tolerances. This can be caused either by a failure of the memory board, the transducer or the connections.	18	Make sure that the cable and its connections are OK. Check that the pins of the tool connector are not pushed in or bent. From menu Maintenance, checking channels, transducer, press F10 to memorize the values. If the problem is not solved, please contact your local Customer Center.
The tool does not start, but the tightening cycle is performed. Tightening report: "Scy" (if the operator releases the trigger before the end of the time delay).	Motor failure	19	Please contact your local customer center.
Tightening report: "Tmin Amin". If you look up the "information" entry, the cycle has been stopped by the "maximum current" instruction.	Motor failure	20	Please contact your local customer center.

Symptoms	Possible causes	N°	Check
The tool does not always start.	Faulty contact in the trigger switch.	21	In the "Maintenance - Inputs/Outputs" menu, check the switching of the concerned input. If there is a fault, please contact your local customer center.
Seen from the controller side, the tool does not reach the programmed torque or hardly reaches it. The motor overheats. The tool is stopped by the "maximum current" instruction.	The angle-head efficiency has deteriorated to a large extent.	23	If the wear of the angle head is low, a dynamic calibration could compensate the drift. If not, please contact your local Customer Center for a maintenance.
	The "memory" board is faulty.	24	Please contact your local Customer Center.
	Motor issue caused either by <ul style="list-style-type: none"> <li>● Damaged stator (motor failure).</li> <li>● Faulty cable.</li> <li>● Faulty servo-driver.</li> </ul>	25	Check that the contacts of the motor connector or of the cable are neither twisted nor pushed back. Replace the servo driver. If the problem is not solved, please contact your local customer center.
	The tuning of the resolver is disturbed(motor failure).	26	No check is possible. Rule out every other possible cause. Please contact your local customer center for maintenance.
Dispersion or abnormal deviation in the tightening results.	The angle head is faulty.	27	This can be confirmed by checking the torque ripple of the "torque versus time" curve saved in the unit. If so, please contact your local Customer Center.
	Transducer or internal connections damaged.	28	Please contact your local Customer Center.
The tool does not run in run reverse mode.	The Tightening / Untightening reversing gearbox is faulty. The run reverse speed is set to 0.	30	In the "Tests, Inputs/outputs" menu, check the switching of bit 7 when the reversing gearbox is activated. Check the "Spindle validation on run reverse" parameter. Test commutation between pins 2 and 5 of the tool connector. Check the value of the run reverse speed in the "Parameters/Station" menu. If the reversing gearbox is running correctly, the tool LEDs should blink.
The tool does not run in tightening mode, but runs in run reverse mode.	Loss of controller memory.	32	Check the presence of tightening cycles. Check that the selected cycle is programmed correctly.
	Transducer fault.	33	Refer to No. 18.
	The Tightening / Untightening reversing gearbox is stuck in run reverse mode.	34	Refer to No. 30.
Temperature.	-	37	Refer to the chapter "Control screen/ Controller temperature" to get the details.

## 14 - GLOSSARY

<b>Acceleration rate</b>	This is the time expressed in seconds for the tool to switch from the initial speed (the speed during the previous phase) to the speed requested in the next phase. The acceleration rate characterizes the acceleration or deceleration of the tool.
<b>Angle reset</b>	This is the action for resetting the angle value. It is usually performed at the beginning of the cycle for the whole cycle but it can also be performed at the beginning of any phase of the cycle. In the latter case, the final torque report takes the events into account from the latestResetting action.
<b>Angle threshold</b>	This is the torque value from which the angle measurement is started in a phase which takes the screw angle as a basis. It is usually set to 50% of the final torque for a "Torque+Angle" tightening strategy. It is set as low as possible from the linear zone of the joint for an "Angle+ Torque" strategy.
<b>Autotest cycle</b>	It is possible to run an autotest cycle to regularly check the correct operation of the tool at free speed. This autotest cycle can be any cycle among the tightening cycles; only its programming is specific to check that the tool runs at a given angle and that the torque transducer provides correct indications. This function is recommended for automatic stations.
<b>AZC</b>	This is an Automatic Zero Control. This task consists in measuring the residual signal of the transducer (offset) when the latter is stress-free, to store it then to subtract it from the measurement. This allows you to display a torque equal to zero when no torque is applied.
<b>Bandwidth</b>	The bandwidth of a system is expressed in Hertz. This is the ability of a system to react more or less rapidly or to eliminate (filter) more or less interferences. For most tightening applications, a 128 Hz bandwidth is defined which allows finding a compromise between speed and filtering. When the bandwidth is reduced, the system filters to a higher extent (eliminates more interferences) but it is slower, which may result in a difference between the torque applied and the torque measured by the system.
<b>Cycle</b>	A cycle is a tightening program which consists of several concatenated phases, each phase being adapted to the various stages of the tightening cycle. Depending on the systems, it is possible to pre-program and select one or several tightening cycles. This allows the same tool to perform tightening with various adjustments.
<b>Ergo-stop</b>	When this functionality is enabled, the jerk felt by the operator at the end of the tightening operation is attenuated.
<b>External stop</b>	Generally speaking, the tool is stopped when the magnitude being monitored (torque, angle, torque rate) has been reached. It is an internal stop. It is possible to cause the tool to stop through an external event generated by a PLC for example. In this case, the "external stop" function must be enabled and the "external stop" input must be connected to the source of the event. The internal stops are no longer active.
<b>Gear ratio coefficient</b>	This coefficient is used when a mechanical subassembly is added to a standard tool and when it modifies the overall mechanical gear ratio of the tool. This is the case when an additional gear ratio stage is positioned on the tool output shaft. The angle value displayed is the angle value measured when the tool is of standard type, multiplied by this coefficient.
<b>Nominal load</b>	The "nominal load" is the value of the torque for which the transducer generates the "sensitivity" signal. This data is stored in the tool. The unit reads the nominal load each time it is switched on and each time there is a tool change in order to constantly compute the correct torque value. This data can be displayed but cannot be modified.
<b>Nominal load coefficient</b>	This coefficient is used when a mechanical subassembly is added to a standard tool and when it modifies the output torque of the tool. This is the case when an additional gear ratio stage is positioned after the torque transducer. The torque value displayed is the torque value measured by the tool transducer, multiplied by this coefficient.
<b>Phase</b>	A phase corresponds to a basic program step of the cycle. The program runs the phases one after another, from the first one to the last one. As an example: a typical cycle includes a runDown speed phase (D) then a final speed phase (F), each containing the data required for their execution. The maximum number of phases varies according to the systems.

<b>Power</b>	This is the word used to define the maximum current and therefore the maximum torque allowed in a phase. It is expressed as a percentage of the maximum current for a given tool. For instance, 100% corresponds to the full power available to run a phase. 50% indicates that the tool will not be able to supply more than 50% of its maximum torque. The Torque / Power correlation is given for information. There is no calibration between these magnitudes.
<b>Safety angle</b>	This is a torque value which causes the tool to stop when the said value is reached whereas all the other stop conditions have failed. This applies to the strategies where the stop magnitude is different from the torque. The safety torque allows you to protect the tool or the joint in the event of a fault.
<b>Sensitivity</b>	Sensitivity is a coefficient expressed in mV/V which indicates the value of the signal generated by the torque transducer when the said transducer is supplied with 1 V and for a torque equal to the "nominal load". This data is stored in the tool. The unit reads the sensitivity each time it is switched on and each time there is a tool change in order to constantly compute the correct torque value. This data can be displayed but cannot be modified.
<b>Station</b>	A station is a combination of tools operating together in a synchronous mode. The simplest station consists of one tool only. The maximum number of tools depends on the system. An overall report is produced for the station.
<b>Torque reset</b>	This is the action for resetting the torque value. It is usually performed at the beginning of the cycle for the whole cycle but it can also be performed at the beginning of any phase of the cycle. In the latter case, the final torque report takes the events into account from the latest Resetting action.

# More Than Productivity



[www.desouttertools.com](http://www.desouttertools.com)

© Copyright 2018