



Ethernet-APL Rail Field Switch

ARS11-B2-IC08-1

- Managed Ethernet-APL field switch for process industries
- Powered spur ports intrinsically safe Ex ic according to 2-WISE and FISCO
- PROFINET MRP, S2 redundancy and dynamic reconfiguration
- 2 ports each for 1000BASE-T and SFP transceivers
- Redundant power input 20 VDC ... 60 VDC
- Installation in Zone 2
- Physical layer diagnostics at the spur
- Configuration and diagnosis with FDI, web interface, PROFINET device functions and SNMP
- Support of network security
- Support of Ethernet-APL and PROFIBUS PA instruments

Ethernet-APL rail field switch with 8 intrinsically safe Ex ic spur ports and screw terminals with proxy support selectable for PROFIBUS PA field devices



ethernet-apl™
advanced physical layer



Function

The Ethernet-APL rail field switch is a ruggedized, managed field switch offering connectivity for Ethernet-APL devices to Ethernet networks via any protocol. The connections, i. e., "spur" ports, provide intrinsically safe (Ex ic) power and communication to instruments located in Zone 2. APL field switches can be installed in Zone 2.

The APL field switch features 2 Gigabit Ethernet ports and 2 SFP ports. The SFP ports provide connections for a choice of optional SFP transceivers to be used in explosion-hazardous areas and different distances. For PROFINET, the APL field switch supports Class B networks. For high-availability installations, the APL field switch provides redundancy mechanisms such as MRP ring redundancy and S2 system redundancy. PROFINET dynamic reconfiguration permits re-configuration of the APL field switch during runtime without interrupting the data exchange.

Easy configuration and diagnostics of the APL field switch are accessible via FDI and web-based management. PROFINET device functions and SNMP assure fast start-up and enable the use of predictive maintenance. Comprehensive network and physical layer diagnostics enable proactive management strategies to reduce risk of failure and downtime.

The APL field switch implements enhanced network security and supports SNMPv3, the locking of unused ports, and the HTTPS protocol.

Function Principle

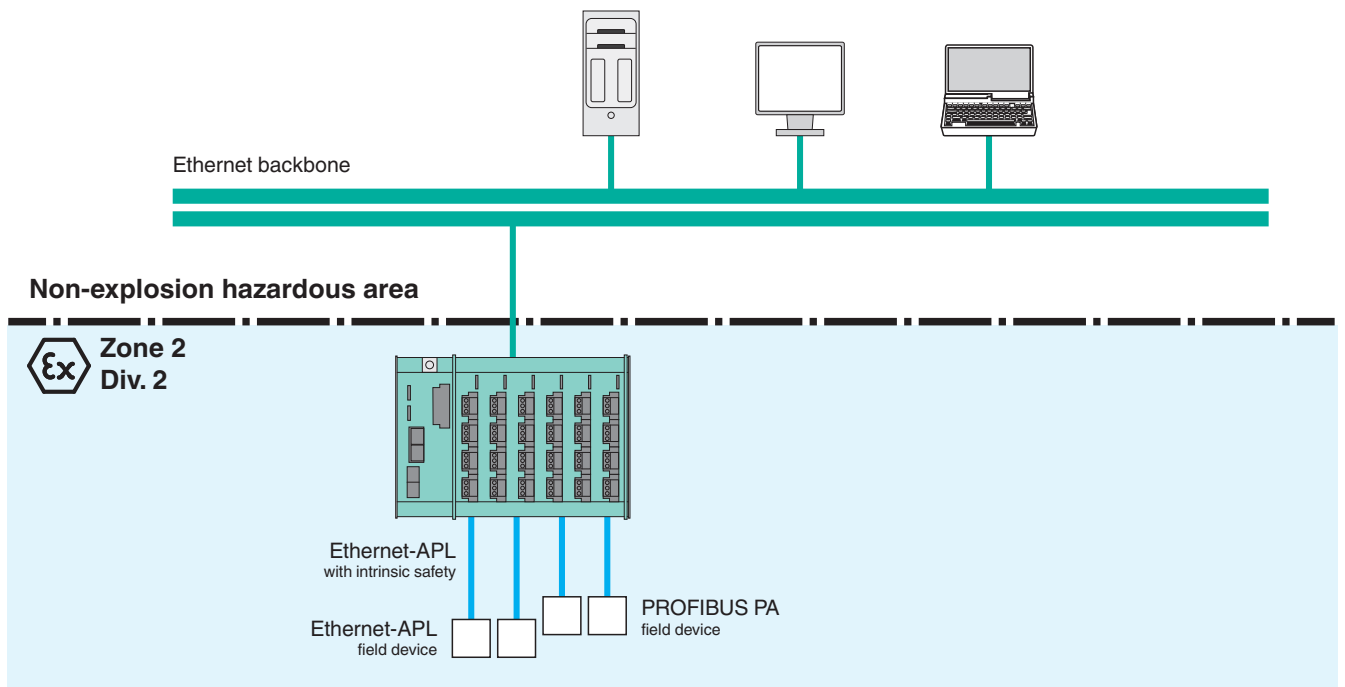

Release date: 2023-08-24 Date of issue: 2023-08-24 Filename: 70121859-100000_eng.pdf

Refer to "General Notes Relating to Pepperl+Fuchs Product Information".

Pepperl+Fuchs Group
www.pepperl-fuchs.com

USA: +1 330 486 0002
pa-info@us.pepperl-fuchs.com

Germany: +49 621 776 2222
pa-info@de.pepperl-fuchs.com

Singapore: +65 6779 9091
pa-info@sg.pepperl-fuchs.com

PF PEPPERL+FUCHS

Dimensions

DIN Rail Mounting

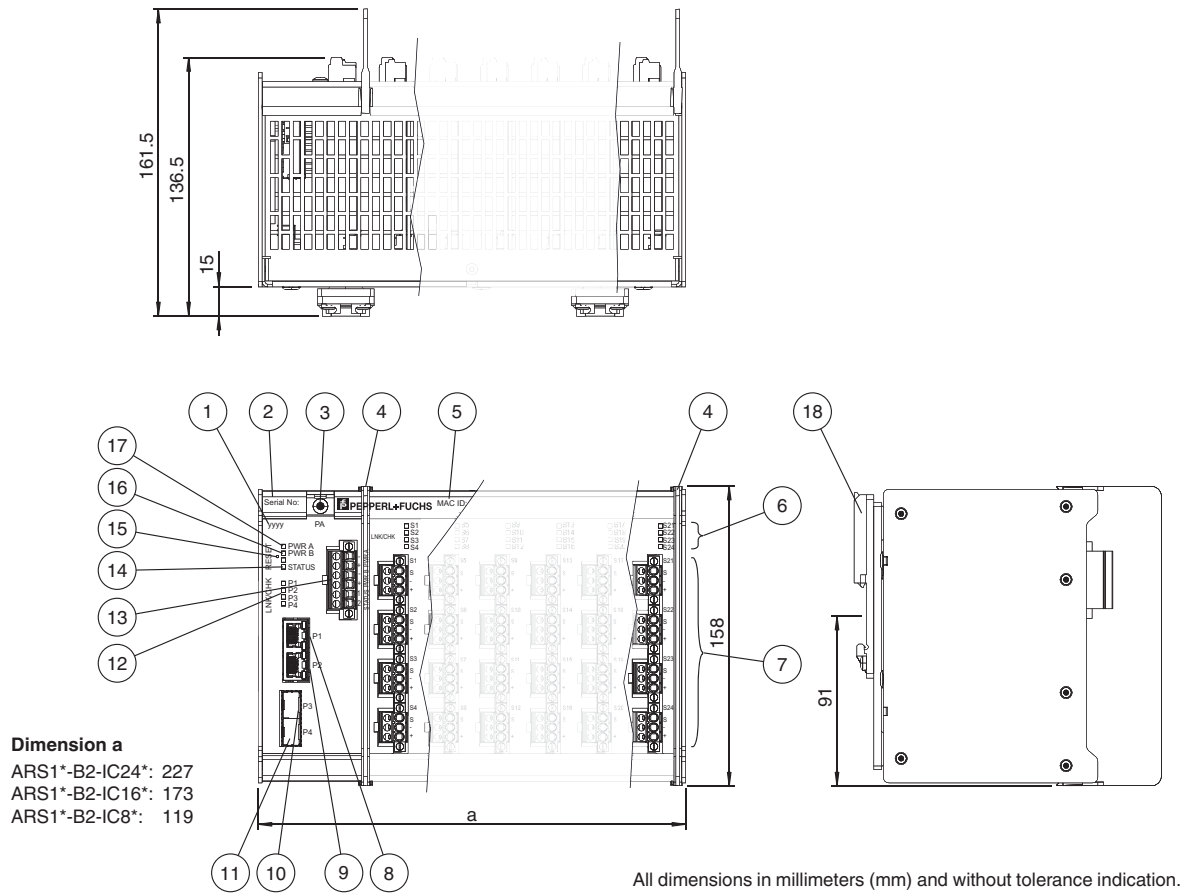

- | | |
|---|---|
| 1 Year of production | 11 Ethernet SFP port P4 |
| 2 Serial number | 12 LED LNK/CHK P1 ... P4, communication status LED P1 ... P4 |
| 3 PA, connection to equipotential bonding | 13 Connector for auxiliary power and status indication output |
| 4 Slot for separation wall | 14 LED STATUS, status rail field switch |
| 5 MAC ID | 15 Reset button |
| 6 LED S1 ... Sn, status spur ports S1 ... Sn | 16 LED PWR B, status power input B |
| 7 Connectors for intrinsically safe spurs S1 ... Sn | 17 LED PWR A, status power input A |
| 8 Ethernet port P1 | 18 DIN rail mounting brackets |
| 9 Ethernet port P2 | |
| 10 Ethernet SFP port P3 | |

Technical Data

General specifications			
Design / Mounting		Cabinet installation	
Fieldbus support		PROFIBUS PA	
Supply			
Rated voltage	U_r	20 ... 60 V	
Rated current	I_r	0.37 ... 1.1 A	
Power dissipation		13.2 W	
Voltage difference dual supply input		+/- 10 %	

Release date: 2023-08-24 Date of issue: 2023-08-24 Filename: 70121859-100000_eng.pdf

Refer to "General Notes Relating to Pepperl+Fuchs Product Information".

Technical Data

Power consumption	max. 22 W
Redundancy	dual supply input
Indicators/operating means	
LED PWR A/B	green: power on
LED LNK/CHK	Off: no communication link active , Green: communication link active , Green flashing: communication link activity , Yellow flashing: communication with PROFIBUS PA field device , Red flashing: check function
LED STATUS	Off: Good , Blue: Maintenance required , Red: Failure
Fault signal	VFC alarm 100 mA, 32 V DC, normally closed
Button	Device reset
Interface 1	
Interface type	Ethernet-APL : 1 Vpp option spur connection , PROFIBUS PA
Port classification	S P C C
Number of ports	8
Port identification	S 1 ... S 8
Power option	powered
Transfer rate	10 MBit/s full duplex
Rated voltage	11.61 V
Rated current	95 mA
Rated power	1.11 W
Cable shield grounding option	capacitive grounded
Connection type	pluggable screw terminals
Conductor cross section solid wire	2.08 ... 0.326 mm ² , 14 ... 18 AWG
Conductor cross section flexible wire	2.08 ... 0.326 mm ² , 14 ... 18 AWG
Interface 2	
Interface type	1000BASE-T
Number of ports	2
Port identification	P 1 ... P 2
Transfer rate	10/100/1000 Mbps
Connection type	RJ-45 , EIA/TIA 568 B
Interface 3	
Interface type	Slot for SFP transceiver SFP Multi-Source (MSA) compliant
Number of ports	2
Port identification	P 3 ... P 4
Galvanic isolation	
Spurs/Supply	1500 V AC
SFP/Supply	500 V AC
1000BASE-T/Supply	1500 V AC
1000BASE-T/Spurs	1500 V AC
1000BASE-T/1000BASE-T	1500 V AC
Housing/All	620 V AC
Fault signal/All	1500 V AC
Directive conformity	
Electromagnetic compatibility	
Directive 2014/30/EU	EN 61326-1:2013
Conformity	
Galvanic isolation	IEC 61010-1
Electromagnetic compatibility	EN 61326 , NE 21
Degree of protection	IEC 60529
Ethernet	IEEE 802.3z , IEEE 802.3u , IEEE 802.3cg

Release date: 2023-08-24 Date of issue: 2023-08-24 Filename: 70121859-100000_eng.pdf

Refer to "General Notes Relating to Pepperl+Fuchs Product Information".

Pepperl+Fuchs Group
www.pepperl-fuchs.com

USA: +1 330 486 0002
pa-info@us.pepperl-fuchs.com

Germany: +49 621 776 2222
pa-info@de.pepperl-fuchs.com

Singapore: +65 6779 9091
pa-info@sg.pepperl-fuchs.com

 **PEPPERL+FUCHS**

Technical Data

Shock resistance		EN 60068-2-27
Vibration resistance		EN 60068-2-6
Climatic conditions		DIN IEC 721
Software		
Industrial protocols		PROFINET , CC-B (PA) , dynamic reconfiguration , Netload Class III , pruning
Management		Web user interface , SNMP v1, v2 , v3 , PROFINET
Redundancy		PROFINET MRP , PROFINET system redundancy S2
Management Information Base (MIB)		PROFINET conformance class B
Cybersecurity		HTTPS , Port locking , Protocol disabling , PROFINET security level 1
Diagnostics function		10BASE-T1L physical layer , port , Packet statistics , PROFIBUS PA
Ambient conditions		
Ambient temperature		-40 ... 70 °C (-40 ... 158 °F) horizontally mounted no SFP installed -40 ... 65 °C (-40 ... 149 °F) horizontally mounted SFP installed
Storage temperature		-40 ... 85 °C (-40 ... 185 °F)
Relative humidity		≤ 95 % non-condensing
Shock resistance		15 g 11 ms
Vibration resistance		1 g 10 ... 150 Hz
Pollution degree		max. 2, according to IEC 60664
Corrosion resistance		acc. to ISA-S71.04-1985, severity level G3
Mechanical specifications		
Housing material		stainless steel 1.4301 , PC (Polycarbonate)
Housing width		119 mm
Housing height		158 mm
Housing depth		136.5 mm
Degree of protection		IP20 according to EN 60529
Mass		2100 g
Mounting		DIN rail mounting , wall mounting
Data for application in connection with hazardous areas		
EU-type examination certificate		TÜV 20 ATEX 8571 X
Marking		Ⓜ II 3 G Ex ic ec nC [ic] IIC T4 Gc Ⓜ II (3) D [Ex ic Dc] IIIC
Supply		
Maximum safe voltage	U_m	60 V
Interface 1		
2-WISE power source, FISCO power supply		
Voltage U_o		17.5 V
Current I_o		105 mA
Interface 2		
Maximum safe voltage U_m		60 V
Interface 3		
Maximum safe voltage U_m		60 V
Directive conformity		
Directive 2014/34/EU		EN 60079-0:2018 , EN 60079-11:2012 , EN 60079-7:2015+A1:2018 , EN 60079-15:2019 , IEC TS 60079-47:2021
International approvals		
IECEx approval		IECEx TUR 20.0105X
Approved for		Ex ic ec nC [ic] IIC T4 Gc [Ex ic Dc] IIIC
Certificates and approvals		
Patents		This product may be covered by the following patent: US 9,762,409
General information		
Supplementary information		Observe the certificates, declarations of conformity, instruction manuals, and manuals where applicable. For information see www.pepperl-fuchs.com .

Release date: 2023-08-24 Date of issue: 2023-08-24 Filename: 70121859-100000_eng.pdf

Refer to "General Notes Relating to Pepperl+Fuchs Product Information".

Pepperl+Fuchs Group
www.pepperl-fuchs.comUSA: +1 330 486 0002
pa-info@us.pepperl-fuchs.comGermany: +49 621 776 2222
pa-info@de.pepperl-fuchs.comSingapore: +65 6779 9091
pa-info@sg.pepperl-fuchs.com

PEPPERL+FUCHS

Assembly

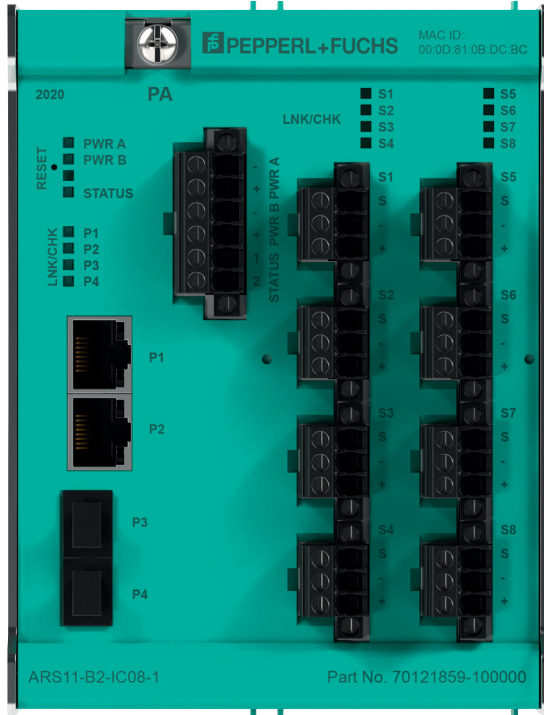

Mounting

Wall Mounting Option

For wall mounting the APL rail field switch use the accessory ACC-ARS-WM. See manual for details and dimensions.

Type Code

ARS1	(1)	B	2	-	IC	(2)	-	(3)
------	-----	---	---	---	----	-----	---	-----

ARS1	Device
ARS1	Ethernet-APL Rail Field Switch

(1)	PROFIBUS PA Proxy
1	With proxy
2	Without proxy

B	Power Supply
B	Separately powered 20 V ... 60 V

2	Uplink Ports
2	2 ports each for RJ45 and SFP slots

IC	Intrinsic Safety at Spurs
IC	Ex ic IIC

(2)	Spur Port Count
08	Spur ports
16	Spur ports
24	Spur ports

(3)	Pluggable Terminal Types
1	Screw terminals
2	Spring terminals







Accessories

	ACC-ARS-SW	Separation wall for intrinsically safe port application (packaging unit: 2 pieces)
---	-------------------	--

Release date: 2023-08-24 Date of issue: 2023-08-24 Filename: 70121859-100000_eng.pdf

Refer to "General Notes Relating to Pepperl+Fuchs Product Information".

Accessories

	ACC-ARS-WMK	Wall mounting kit consisting of 2 mounting brackets
	ACC-PC-SFP	Protective covers for SFP sockets (packaging unit: 10 pieces)
	ACC-PC-45	Protective covers for RJ45 sockets (packaging unit: 10 pieces)
	SFP-1	SFP transceiver, 2 km, 100BASE-FX, fast Ethernet multimode fiber
	SFP-2	SFP transceiver, 550 m, 1000BASE-SX, Gigabit Ethernet multimode fiber
	DTM FieldConnex	FieldConnex® DTM Collection

Release date: 2023-08-24 Date of issue: 2023-08-24 Filename: 70121859-100000_eng.pdf

Refer to "General Notes Relating to Pepperl+Fuchs Product Information".

Pepperl+Fuchs Group
www.pepperl-fuchs.com

USA: +1 330 486 0002
pa-info@us.pepperl-fuchs.com

Germany: +49 621 776 2222
pa-info@de.pepperl-fuchs.com

Singapore: +65 6779 9091
pa-info@sg.pepperl-fuchs.com